

ENTERPRISE TABLET

**ET401**

# Product Reference Guide

MN-005318-03EN Rev. A

---



Zebra Technologies | 3 Overlook Point | Lincolnshire, IL 60069 USA  
[zebra.com](http://zebra.com)

2026/04/09

The Zebra wordmark and logo are trademarks of Zebra Technologies Corp., registered in many jurisdictions worldwide. All other trademarks are the property of their respective owners. ©2026 Zebra Technologies Corp. and/or its affiliates.

Information in this document is subject to change without notice. The software described in this document is furnished under a license agreement or nondisclosure agreement. The software may be used or copied only in accordance with the terms of those agreements.

For further information regarding legal and proprietary statements, please go to:

SOFTWARE: [zebra.com/informationpolicy](https://zebra.com/informationpolicy).

COPYRIGHTS: [zebra.com/copyright](https://zebra.com/copyright).

PATENTS: [ip.zebra.com](https://ip.zebra.com).

WARRANTY: [zebra.com/warranty](https://zebra.com/warranty).

END USER LICENSE AGREEMENT: [zebra.com/eula](https://zebra.com/eula).

## Terms of Use

### Proprietary Statement

This manual contains proprietary information of Zebra Technologies Corporation and its subsidiaries ("Zebra Technologies"). It is intended solely for the information and use of parties operating and maintaining the equipment described herein. Such proprietary information may not be used, reproduced, or disclosed to any other parties for any other purpose without the express, written permission of Zebra Technologies.

### Product Improvements

Continuous improvement of products is a policy of Zebra Technologies. All specifications and designs are subject to change without notice.

### Liability Disclaimer

Zebra Technologies takes steps to ensure that its published Engineering specifications and manuals are correct; however, errors do occur. Zebra Technologies reserves the right to correct any such errors and disclaims liability resulting therefrom.

### Limitation of Liability

In no event shall Zebra Technologies or anyone else involved in the creation, production, or delivery of the accompanying product (including hardware and software) be liable for any damages whatsoever (including, without limitation, consequential damages including loss of business profits, business interruption, or loss of business information) arising out of the use of, the results of use of, or inability to use such product, even if Zebra Technologies has been advised of the possibility of such damages. Some jurisdictions do not allow the exclusion or limitation of incidental or consequential damages, so the above limitation or exclusion may not apply to you.

# Contents

|  |           |
|--|-----------|
| <b>About this Guide.....</b>                           | <b>11</b> |
| Configurations.....                                    | 11        |
| Notational Conventions.....                            | 14        |
| Icon Conventions.....                                  | 14        |
| Service Information.....                               | 15        |
| Determining Software Versions.....                     | 15        |
| Determining the Serial Number.....                     | 16        |
| <br>   |           |
| <b>Getting Started.....</b>                            | <b>17</b> |
| Unpacking the Device.....                              | 17        |
| Device Features.....                                   | 18        |
| Setting Up the Device.....                             | 20        |
| Installing the nano SIM Card and the microSD Card..... | 20        |
| Turning off the Display.....                           | 25        |
| Turning off the Device.....                            | 25        |
| <br>   |           |
| <b>Using the Device.....</b>                           | <b>26</b> |
| Home Screen.....                                       | 26        |
| Setting the Home Screen Rotation.....                  | 27        |
| Status Bar.....  | 27        |
| Notification Icons.....                                | 28        |
| Status Icons.....                                      | 29        |
| Managing Notifications.....                            | 31        |
| Opening the Quick Access Panel.....                    | 32        |
| Quick Access Panel Icons.....                          | 33        |

|  |           |
|--|-----------|
| Editing the Quick Access Tiles.....              | 35        |
| Battery Management.....                          | 36        |
| Low Battery Notification.....                    | 36        |
| Battery-less Operation.....                      | 36        |
| Checking Battery Status.....                     | 36        |
| Monitoring Battery Usage.....                    | 37        |
| Interactive Sensor Technology.....               | 37        |
| Waking the Device.....                           | 37        |
| USB Communication.....                           | 38        |
| Transferring Files.....                          | 38        |
| Transferring Photos.....                         | 38        |
| Disconnecting from the Host Computer.....        | 39        |
| <b>Settings.....</b>                             | <b>40</b> |
| Accessing Settings.....                          | 40        |
| Display Settings.....                            | 40        |
| Setting the Screen Brightness Automatically..... | 40        |
| Setting the Screen Brightness Manually.....      | 40        |
| Setting Night Light.....                         | 40        |
| Setting Screen Rotation.....                     | 41        |
| Setting Screen Timeout.....                      | 41        |
| Setting Lock Screen Notifications.....           | 41        |
| Setting Font and Display Size.....               | 42        |
| Setting Touch Panel Mode.....                    | 42        |
| Setting the Date and Time.....                   | 42        |
| General Sound Setting.....                       | 43        |
| Sound Options.....                               | 43        |
| Zebra Volume Controls.....                       | 44        |
| Remapping a Button.....                          | 44        |
| Remappable Keys.....                             | 45        |
| Keyboards.....                                   | 45        |
| Enabling Keyboards.....                          | 46        |
| Switching Between Keyboards.....                 | 46        |
| Using the Keyboards.....                         | 46        |

|   |           |
|---|-----------|
| Language Usage.....                                   | 47        |
| Changing the Language Setting.....                    | 47        |
| Adding Words to the Dictionary.....                   | 48        |
| Notifications.....                                    | 48        |
| Enabling Blink Light.....                             | 48        |
| <b>Applications.....</b>                              | <b>49</b> |
| Installed Applications.....                           | 49        |
| Accessing Apps.....                                   | 50        |
| Switching Between Recent Apps.....                    | 50        |
| Battery Manager.....                                  | 51        |
| Opening Battery Manager.....                          | 51        |
| Battery Manager Information.....                      | 51        |
| Camera.....   | 53        |
| Taking Photos.....                                    | 53        |
| Recording Videos.....                                 | 54        |
| Camera Settings.....                                  | 55        |
| Camera Preview Size Limitation.....                   | 56        |
| DWDemo.....   | 56        |
| DWDemo Icons.....                                     | 56        |
| Selecting a Scanner.....                              | 57        |
| <b>Data Capture.....</b>                              | <b>58</b> |
| Imaging.....  | 58        |
| Scanning Considerations.....                          | 58        |
| Scanning with an Internal Scanner.....                | 59        |
| Scanning with the Camera.....                         | 60        |
| Scanning with the RS507/RS507X Hands-Free Imager..... | 61        |
| Scanning with the RS5100 Ring Scanner.....            | 63        |
| Scanning with the RS6000 Bluetooth Ring Scanner.....  | 64        |
| Scanning with the RS6100 Bluetooth Ring Scanner.....  | 66        |
| Scanning with the DS2278 Digital Scanner.....         | 68        |
| Scanning with the DS3678 Bluetooth Scanner.....       | 69        |

|  |           |
|--|-----------|
| Scanning with the DS8178 Digital Scanner.....                        | 71        |
| Scanning with the LI3678 Linear Imager.....                          | 72        |
| DataWedge.....   | 73        |
| Enabling DataWedge.....  | 73        |
| Disabling DataWedge.....   | 74        |
| Pairing a Bluetooth Ring Scanner.....                                | 74        |
| Pairing in SSI Mode Using Near Field Communication.....              | 74        |
| Pairing in HID Mode Using Near Field Communication.....              | 74        |
| Pairing Using Simple Serial Interface (SSI).....                     | 75        |
| Pairing the Ring Scanner Using Bluetooth Human Interface Device..... | 76        |
| Pairing a Bluetooth Scanner.....                                     | 77        |
| Pairing Using Simple Serial Interface.....                           | 77        |
| Pairing Using Bluetooth Human Interface Device.....                  | 78        |
| Supported Decoders.....  | 79        |
| SE4100 Internal Imager Supported Decoders.....                       | 79        |
| SR500 Internal Imager Supported Decoders.....                        | 80        |
| Camera Supported Decoders.....                                       | 81        |
| RS507/RS507x Supported Decoders.....                                 | 81        |
| RS5100 Supported Decoders.....                                       | 82        |
| RS6000 Supported Decoders.....                                       | 83        |
| RS6100 Supported Decoders.....                                       | 84        |
| DS2278 Supported Decoders.....                                       | 85        |
| DS3678 Supported Decoders.....                                       | 85        |
| DS8178 Supported Decoders.....                                       | 86        |
| LI3678 Supported Decoders.....                                       | 87        |
| <b>Wireless.....</b>   | <b>89</b> |
| Wireless Wide Area Networks.....                                     | 89        |
| Sharing the Mobile Data Connection.....                              | 89        |
| Data Usage.....  | 91        |
| Cellular Network Settings.....                                       | 92        |
| Supported Frequency Bands.....                                       | 94        |
| Wireless Local Area Networks.....                                    | 96        |
| Connecting to a Wi-Fi Network.....                                   | 97        |

|   |            |
|---|------------|
| Removing a Wi-Fi Network.....                         | 97         |
| WLAN Configuration.....                               | 98         |
| Bluetooth.....  | 103        |
| Adaptive Frequency Hopping.....                       | 103        |
| Security.....   | 104        |
| Bluetooth Profiles.....                               | 104        |
| Bluetooth Power States.....                           | 105        |
| Enabling Bluetooth.....                               | 105        |
| Disabling Bluetooth.....                              | 105        |
| Discovering Bluetooth Device(s).....                  | 106        |
| Changing the Bluetooth Name.....                      | 106        |
| Connecting to a Bluetooth Device.....                 | 106        |
| Selecting Profiles on the Bluetooth Device.....       | 106        |
| Unpairing a Bluetooth Device.....                     | 107        |
| Cast.....   | 107        |
| Near Field Communications.....                        | 107        |
| Reading NFC Cards.....                                | 108        |
| Enterprise NFC Settings.....                          | 108        |
| <b>Accessories.....</b>                               | <b>109</b> |
| Charging the Device.....                              | 112        |
| Charging Indicators.....                              | 113        |
| Charging Temperature.....                             | 113        |
| 1-Slot Power Delivery (PD) Charging Cradle.....       | 113        |
| Setup.....  | 115        |
| 4-Slot Charge-Only Cradle.....                        | 115        |
| Setup.....  | 117        |
| Installing the Insert.....                            | 118        |
| Connect Hub.....                                      | 120        |
| Inserting the Device into the Connect Hub Cradle..... | 121        |
| PowerPack.....  | 122        |
| Installing the PowerPack.....                         | 123        |
| PowerPack Charging Indicators.....                    | 124        |
| 4-Slot PowerPack Battery Charger.....                 | 125        |

|  |            |
|--|------------|
| Setup.....   | 126        |
| Installing the 4-Slot PowerPack Battery Charger.....                 | 126        |
| Rugged Boot.....   | 127        |
| Installing the Rugged Boot.....                                      | 127        |
| Adapter Boot.....  | 128        |
| Installing the Adapter Boot.....                                     | 128        |
| D-Clips.....   | 131        |
| Attaching the Shoulder Strap.....                                    | 132        |
| Expansion Back.....  | 133        |
| Installing the Expansion Back.....                                   | 133        |
| Removing the Expansion Back.....                                     | 135        |
| Replacing the Hand Strap.....  | 136        |
| VESA Mount.....  | 139        |
| Installing the VESA Mount.....                                       | 139        |
| <b>Application Deployment.....</b>                                   | <b>144</b> |
| Android Security.....  | 144        |
| Secure Certificates.....   | 144        |
| Installing a Secure Certificate.....                                 | 144        |
| Android Development Tools.....                                       | 145        |
| Android Development Workstation.....                                 | 145        |
| Enabling Developer Options.....                                      | 145        |
| EMDK for Android.....  | 145        |
| StageNow for Android.....  | 146        |
| GMS Restricted.....  | 146        |
| ADB USB Setup.....   | 146        |
| Application Installation.....  | 147        |
| Installing Applications Using the USB Connection.....                | 148        |
| Installing Applications Using the Android Debug Bridge.....          | 148        |
| Installing Applications Using the Wireless Android Debug Bridge..... | 149        |
| Installing Applications Using a USB Drive.....                       | 150        |
| Uninstalling an Application.....                                     | 151        |
| Android System Update.....   | 151        |
| Performing a System Update Using ADB.....                            | 151        |

|  |            |
|--|------------|
| Performing a System Update Using a USB Drive.....  | 152        |
| Performing a System Update Using a microSD Card.....   | 152        |
| Verifying System Update Installation.....  | 153        |
| Android Enterprise Reset.....  | 153        |
| Performing an Enterprise Reset Using ADB.....  | 154        |
| Performing an Enterprise Reset Using USB Drive.....  | 154        |
| Performing an Enterprise Reset Using a microSD Card.....   | 155        |
| Performing an Enterprise Reset From Device Settings.....   | 155        |
| Android Factory Reset.....   | 155        |
| Performing a Factory Reset Using ADB.....  | 155        |
| Performing a Factory Reset Using a USB Drive.....  | 156        |
| Performing a Factory Reset Using a microSD card.....   | 157        |
| Android Storage.....   | 157        |
| Random Access Memory.....  | 157        |
| Internal Storage.....  | 158        |
| External Storage.....  | 158        |
| Enterprise Folder.....   | 159        |
| Managing Apps.....   | 159        |
| App Details.....   | 159        |
| Managing Downloads.....  | 160        |
| <b>Maintenance and Troubleshooting.....</b>  | <b>161</b> |
| Maintaining the Device.....  | 161        |
| Battery Safety Guidelines.....   | 161        |
| Best Practices for Enterprise Mobile Devices Operating in Hot Environments and<br>Direct Sunlight..... | 162        |
| Properly Plugging and Unplugging a USB-C Cable.....  | 162        |
| Cleaning Instructions.....   | 163        |
| Approved Cleanser Active Ingredients.....  | 163        |
| Harmful Ingredients.....   | 164        |
| Special Cleaning Notes.....  | 164        |
| Cleaning Frequency.....  | 164        |
| Device Cleaning Instructions.....  | 164        |
| Display.....   | 164        |

|  |            |
|--|------------|
| Housing.....                                   | 164        |
| Camera and Exit Window.....                    | 165        |
| Cleaning Cradle Connectors.....                | 165        |
| Cleaning the Speaker Area.....                 | 165        |
| Shelf Mode.....                                | 166        |
| Using Shelf Mode.....                          | 166        |
| Troubleshooting.....                           | 167        |
| Resetting the Device.....                      | 167        |
| Device Troubleshooting.....                    | 167        |
| 1-Slot PD Charging Cradle Troubleshooting..... | 170        |
| 4-Slot Cradle-Only Troubleshooting.....        | 170        |
| 4-Slot PowerPack Charger Troubleshooting.....  | 171        |
| <b>Technical Specifications.....</b>           | <b>172</b> |
| SE4100 Decode Distances.....                   | 172        |
| SR500 Decode Distances.....                    | 173        |
| 1-Slot PD Charging Cradle Specifications.....  | 173        |
| 4-Slot Charge Only Cradle Specifications.....  | 174        |
| 4-Slot PowerPack Specifications.....           | 174        |
| 8 in. Expansion Back Specifications.....       | 175        |
| 10 in. Expansion Back Specifications.....      | 176        |

# About this Guide

This guide provides information about setting up and using the device. Some screens shown in this guide may differ from the actual screens shown on the device.

This guide includes Android™ operating system (OS) 15.

## Configurations

This section details the device configurations with key specifications.



**NOTE:** All configurations support WPAN: Bluetooth 6.0 for seamless wireless connectivity.

**Table 1** Essential Configuration Table

| Configuration       | Operating System | Radio    | Display | Memory/Storage       | Data Capture |
|---------------------|------------------|----------|---------|----------------------|--------------|
| ET4010A-0V101F0P-A6 | Android GMS      | Wi-Fi 6E | 8"      | 6GB RAM / 64GB Flash | N/A          |
| ET4010A-0V101F0P-NA | Android GMS      | Wi-Fi 6E | 8"      | 6GB RAM / 64GB Flash | N/A          |
| ET4010B-0V101F0P-A6 | Android GMS      | Wi-Fi 6E | 10"     | 6GB RAM / 64GB Flash | N/A          |
| ET4010B-0V101F0P-NA | Android GMS      | Wi-Fi 6E | 10"     | 6GB RAM / 64GB Flash | N/A          |
| ET401EA-3V101F2P-A6 | Android GMS      | 5G       | 8"      | 6GB RAM / 64GB Flash | N/A          |
| ET401EA-3V101F2P-NA | Android GMS      | 5G       | 8"      | 6GB RAM / 64GB Flash | N/A          |
| ET401EB-3V101F2P-A6 | Android GMS      | 5G       | 10"     | 6GB RAM / 64GB Flash | N/A          |
| ET401EB-3V101F2P-NA | Android GMS      | 5G       | 10"     | 6GB RAM / 64GB Flash | N/A          |

**Table 2** Standard Configuration Table

| Configuration       | Operating System | Radio   | Display | Memory/Storage        | Data Capture |
|---------------------|------------------|---------|---------|-----------------------|--------------|
| ET4010A-00101B0P-A6 | Android GMS      | Wi-Fi7  | 8"      | 6GB RAM / 64GB Flash  | N/A          |
| ET4010A-00101B0P-NA | Android GMS      | Wi-Fi 7 | 8"      | 6GB RAM / 64GB Flash  | N/A          |
| ET4010A-001C1B0P-A6 | Android GMS      | Wi-Fi 7 | 8"      | 6GB RAM / 64GB Flash  | SE4100       |
| ET4010A-001C1B0P-FT | Android GMS      | Wi-Fi7  | 8"      | 6GB RAM / 64GB Flash  | SE4100       |
| ET4010A-001C1B0P-NA | Android GMS      | Wi-Fi 7 | 8"      | 6GB RAM / 64GB Flash  | SE4100       |
| ET4010A-001C1B0P-TR | Android GMS      | Wi-Fi 7 | 8"      | 6GB RAM / 64GB Flash  | SE4100       |
| ET4010A-001C2B0P-A6 | Android GMS      | Wi-Fi 7 | 8"      | 8GB RAM / 128GB Flash | SE4100       |
| ET4010A-001C2B0P-NA | Android GMS      | Wi-Fi 7 | 8"      | 8GB RAM / 128GB Flash | SE4100       |
| ET4010A-002C1B0P-CN | Android AOSP     | Wi-Fi 7 | 8"      | 6GB RAM / 64GB Flash  | SE4100       |
| ET4010B-00101B0P-A6 | Android GMS      | Wi-Fi 7 | 10"     | 6GB RAM / 64GB Flash  | N/A          |
| ET4010B-00101B0P-NA | Android GMS      | Wi-Fi 7 | 10"     | 6GB RAM / 64GB Flash  | N/A          |
| ET4010B-001C1B0P-A6 | Android GMS      | Wi-Fi 7 | 10"     | 6GB RAM / 64GB Flash  | SE4100       |
| ET4010B-001C1B0P-FT | Android GMS      | Wi-Fi 7 | 10"     | 6GB RAM / 64GB Flash  | SE4100       |
| ET4010B-001C1B0P-NA | Android GMS      | Wi-Fi 7 | 10"     | 6GB RAM / 64GB Flash  | SE4100       |
| ET4010B-001C1B0P-TR | Android GMS      | Wi-Fi 7 | 10"     | 6GB RAM / 64GB Flash  | SE4100       |
| ET4010B-001C2B0P-A6 | Android GMS      | Wi-Fi 7 | 10"     | 8GB RAM / 128GB Flash | SE4100       |
| ET4010B-001C2B0P-NA | Android GMS      | Wi-Fi 7 | 10"     | 8GB RAM / 128GB Flash | SE4100       |
| ET4010B-002C1B0P-CN | Android AOSP     | Wi-Fi 7 | 10"     | 6GB RAM / 64GB Flash  | SE4100       |
| ET401EA-30101B2P-A6 | Android GMS      | 5G      | 8"      | 6GB RAM / 64GB Flash  | N/A          |
| ET401EA-30101B2P-NA | Android GMS      | 5G      | 8"      | 6GB RAM / 64GB Flash  | N/A          |
| ET401EA-301P1B2P-A6 | Android GMS      | 5G      | 8"      | 6GB RAM / 64GB Flash  | SR500        |

**Table 2** Standard Configuration Table (Continued)

| Configuration       | Operating System | Radio | Display | Memory/Storage        | Data Capture |
|---------------------|------------------|-------|---------|-----------------------|--------------|
| ET401EA-301P1B2P-FT | Android GMS      | 5G    | 8"      | 6GB RAM / 64GB Flash  | SR500        |
| ET401EA-301P1B2P-ID | Android GMS      | 5G    | 8"      | 6GB RAM / 64GB Flash  | SR500        |
| ET401EA-301P1B2P-NA | Android GMS      | 5G    | 8"      | 6GB RAM / 64GB Flash  | SR500        |
| ET401EA-301P1B2P-TR | Android GMS      | 5G    | 8"      | 6GB RAM / 64GB Flash  | SR500        |
| ET401EA-301P2B2P-A6 | Android GMS      | 5G    | 8"      | 8GB RAM / 128GB Flash | SR500        |
| ET401EA-301P2B2P-NA | Android GMS      | 5G    | 8"      | 8GB RAM / 128GB Flash | SR500        |
| ET401EB-30101B2P-A6 | Android GMS      | 5G    | 10"     | 6GB RAM / 64GB Flash  | N/A          |
| ET401EB-30101B2P-NA | Android GMS      | 5G    | 10"     | 6GB RAM / 64GB Flash  | N/A          |
| ET401EB-301P1B2P-A6 | Android GMS      | 5G    | 10"     | 6GB RAM / 64GB Flash  | SR500        |
| ET401EB-301P1B2P-FT | Android GMS      | 5G    | 10"     | 6GB RAM / 64GB Flash  | SR500        |
| ET401EB-301P1B2P-NA | Android GMS      | 5G    | 10"     | 6GB RAM / 64GB Flash  | SR500        |
| ET401EB-301P2B2P-A6 | Android GMS      | 5G    | 10"     | 8GB RAM / 128GB Flash | SR500        |
| ET401EB-301P2B2P-FT | Android GMS      | 5G    | 10"     | 8GB RAM / 128GB Flash | SR500        |
| ET401EB-301P2B2P-NA | Android GMS      | 5G    | 10"     | 8GB RAM / 128GB Flash | SR500        |
| ET401EB-301P2B2P-TR | Android GMS      | 5G    | 10"     | 8GB RAM / 128GB Flash | SR500        |

**Table 3** Premium Configuration Table

| Configuration       | Operating System | Radio   | Display | Memory/Storage        | Data Capture |
|---------------------|------------------|---------|---------|-----------------------|--------------|
| ET4015A-0P1P2E1E-A6 | Android GMS      | Wi-Fi 7 | 8"      | 8GB RAM / 128GB Flash | RFID, SR500  |
| ET4015A-0P1P2E1E-NA | Android GMS      | Wi-Fi 7 | 8"      | 8GB RAM / 128GB Flash | RFID, SR500  |
| ET4015B-0P1P2E1E-A6 | Android GMS      | Wi-Fi 7 | 10"     | 8GB RAM / 128GB Flash | RFID, SR500  |

**Table 3** Premium Configuration Table (Continued)

| Configuration       | Operating System | Radio   | Display | Memory/Storage        | Data Capture |
|---------------------|------------------|---------|---------|-----------------------|--------------|
| ET4015B-0P1P2E1E-NA | Android GMS      | Wi-Fi 7 | 10"     | 8GB RAM / 128GB Flash | RFID, SR500  |
| ET401EA-3P1P2E1E-A6 | Android GMS      | 5G      | 8"      | 8GB RAM / 128GB Flash | RFID, SR500  |
| ET401EA-3P1P2E1E-NA | Android GMS      | 5G      | 8"      | 8GB RAM / 128GB Flash | RFID, SR500  |
| ET401EB-3P1P2E1E-A6 | Android GMS      | 5G      | 10"     | 8GB RAM / 128GB Flash | RFID, SR500  |
| ET401EB-3P1P2E1E-NA | Android GMS      | 5G      | 10"     | 8GB RAM / 128GB Flash | RFID, SR500  |

## Notational Conventions

The following notational conventions make the content of this document easy to navigate.

- **Bold** text is used to highlight the following:
  - Dialog box, window, and screen names
  - Dropdown list and list box names
  - Checkbox and radio button names
  - Icons on a screen
  - Key names on a keypad
  - Button names on a screen
- Bullets (•) indicate:
  - Action items
  - List of alternatives
  - Lists of required steps that are not necessarily sequential
- Sequential lists (for example, those that describe step-by-step procedures) appear as numbered lists.

## Icon Conventions

The documentation set is designed to give the reader more visual clues. The following visual indicators are used throughout the documentation set.



**NOTE:** The text here indicates information that is supplemental for you to know and that is not required to complete a task.



**IMPORTANT:** The text here indicates information that is important for you to know.



**CAUTION:** If the precaution is not heeded, you could receive a minor or moderate injury.



**WARNING:** If danger is not avoided, you CAN be seriously injured or killed.



**DANGER:** If danger is not avoided, you WILL be seriously injured or killed.

## Service Information

If you have a problem with your equipment, contact Zebra Global Customer Support for your region. Contact information is available at: [zebra.com/support](https://zebra.com/support).

When contacting support, please have the following information available:

- Serial number of the unit
- Model number or product name
- Software/firmware type and version number

Zebra responds to calls by email, telephone, or fax within the time limits set forth in support agreements.

If your problem cannot be solved by Zebra Customer Support, you may need to return your equipment for servicing and will be given specific directions. Zebra is not responsible for any damages incurred during shipment if the approved shipping container is not used. Shipping the units improperly can possibly void the warranty.

If you purchased your Zebra business product from a Zebra business partner, contact that business partner for support.

## Determining Software Versions

Before contacting Customer Support, determine the current software version on your device.

1. Swipe down from the Status bar to open the Quick Access panel, and then touch .
2. Touch **About tablet**.
3. Scroll to view the following information:

### Basic info

- Device name
- Phone number (WWAN only)
- Battery Information
- Phone information (WWAN only)
- Emergency information

### Legal & regulatory

- Legal information
- SW components

### Device details

- SIM status (WWAN only)
- Model
- EID (WWAN only)

- IMEI (WWAN only)
- Android version

### Device identifiers

- IP address
- Wi-Fi MAC address
- Device Wi-Fi MAC address
- Bluetooth address
- Uptime
- Build Fingerprint
- Build number

To determine the device's International Mobile Equipment Identity (IMEI) information (WWAN only), touch **About tablet** > **IMEI**.

- **IMEI** - Displays the IMEI number for the device.
- **IMEISV** - Displays the IMEI software version (SV) number for the device.

## Determining the Serial Number

Before contacting Customer Support, determine the serial number of your device.

1. Swipe down from the Status bar with two fingers to open the Quick Access panel, and then touch .
2. Touch **About tablet**.
3. Touch **Model**.

# Getting Started

This section provides information on getting the device up and running for the first time.

## Unpacking the Device

When you receive the device, ensure all items are in the box.

1. Carefully remove all protective material from the device and save the shipping container for later storage and shipping.
2. Verify the following items are in the box:
  - Device
  - Regulatory Guide
3. Inspect the equipment for damage. Contact the Global Customer Support Center immediately if any equipment is missing or damaged.
4. Before using the device for the first time, remove the protective shipping film covering the scanner, display, and camera windows.

## Device Features

This section lists and describes the features of the device.

**Figure1** 8 in. Front View

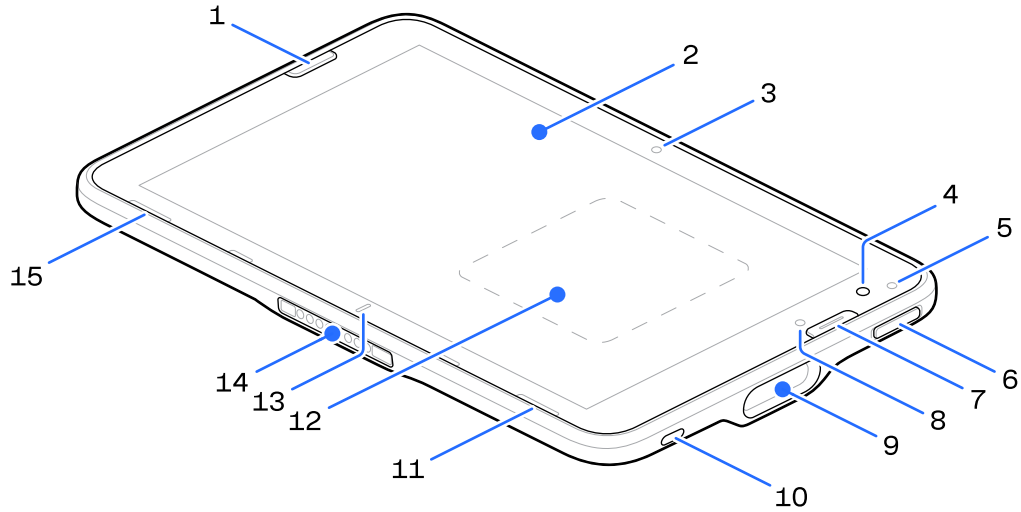

**Figure2** 10 in. Front View

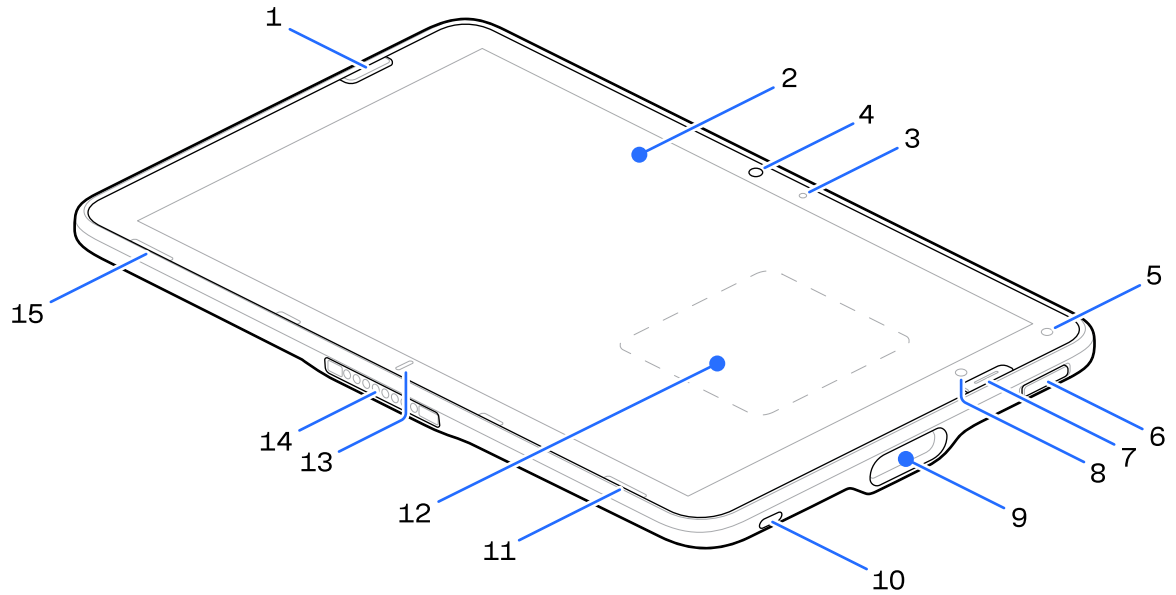

**Table 4** 8 in. and 10 in. Front View

| Number | Item              | Description   |
|--------|-------------------|---|
| 1      | Front scan button | Initiates barcode data capture when a scan-enabled application is active. |
| 2      | Touch screen      | Displays all information needed to operate the device.                    |

**Table 4** 8 in. and 10 in. Front View (Continued)

| Number | Item  | Description  |
|--------|---|--|
| 3      | Charging indicator LED                              | Indicates power state and battery charging status while charging and application-generated notifications.  |
| 4      | Front camera  | Use for video conferencing.  |
| 5      | Light sensor  | Determines ambient light for controlling display backlight intensity.  |
| 6      | Power button  | Turns the display on and off. Press and release to power on the device. Press and hold to reset the device or power off.   |
| 7      | Programmable button                                 | Button that is configurable for use with applications.   |
| 8      | Data capture LED                                    | Illuminates during data capture.   |
| 9      | Scan window (optional, based on the specific model) | Provides data capture using the imager.  |
| 10     | USB-C port  | Provides USB host and client communications.   |
| 11     | Right speaker                                       | Provides audio output.   |
| 12     | NFC antenna   | Enables short-range wireless data exchange with NFC-enabled devices.   |
| 13     | Cradle alignment indicator                          | Use to assist in aligning the device with a cradle.  |
| 14     | Interface connector                                 | Provides communication to the device from the dock.<br> <b>NOTE:</b> The connector is excluded from the Essentials SKU. |
| 15     | Left speaker  | Provides audio output.   |

**Figure 3** 8 in. and 10 in. Rear View

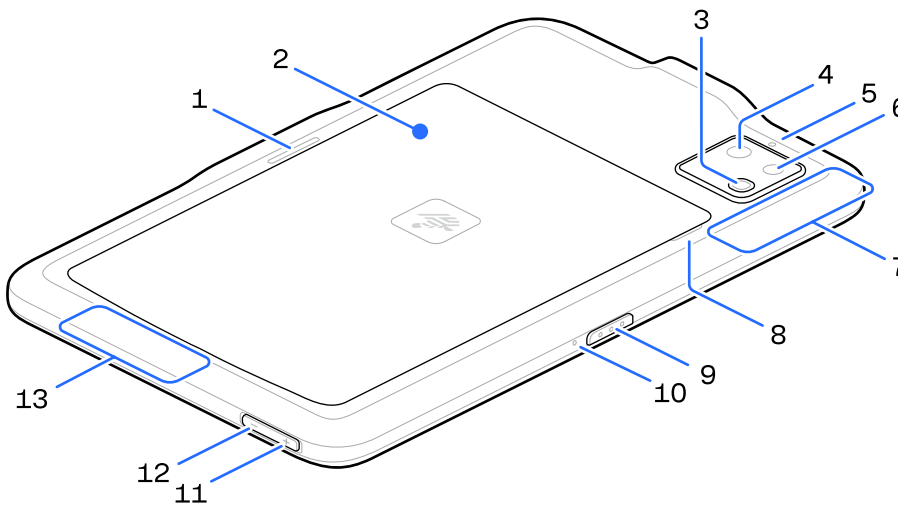

**Table 5** 8 in. and 10 in. Rear View

| Number | Item                               | Description  |
|--------|------------------------------------|--|
| 1      | Cradle latching slot               | Used by cradles to secure the device.  |
| 2      | Battery cover                      | Provides access to the replaceable battery.  |
| 3      | Rear camera LED flash              | Provides illumination for the camera.  |
| 4      | Ultra-Wide-Angle (UWA) rear camera | Captures a wider field of view for detailed photos (available on premium SKUs only).       |
| 5      | Rear microphone                    | Use for audio recordings.  |
| 6      | Rear camera                        | Autofocus camera that takes photos.  |
| 7      | Integrated RFID                    | Ultra-high frequency (UHF) RFID.   |
| 8      | Battery cover notch                | Lift the notched section of the battery cover to remove the battery cover from the device. |
| 9      | Top scan button                    | Initiates barcode data capture when a scan-enabled application is active (programmable).   |
| 10     | Top microphone                     | Use for voice communications or audio recordings.  |
| 11     | Volume up button                   | Increases audio volume.  |
| 12     | Volume down button                 | Decreases the audio volume.  |
| 13     | Integrated RFID                    | Ultra-high frequency (UHF) RFID.   |

## Setting Up the Device

Set up the device before using it for the first time.

1. Install the nano SIM card (WAN devices only).
2. Insert the microSD card (if required for your application).
3. Charge the device.
4. Power on the device.

### Installing the nano SIM Card and the microSD Card

The slot is located within the battery well and is found after removing the battery. The SIM/SD card drawer can hold one SIM card and one microSD card.



**CAUTION:** Do not attempt to remove the battery while the device is powered on.

1. Press and hold the Power button until the menu appears. Touch **Power off**.
2. Hold the device down with one hand and lift the corner of the battery cover up from the notched area.



**CAUTION:** Do not use any tools for battery cover or battery removal. Puncturing the battery or seal may cause a hazardous condition and a potential risk of injury.

## Getting Started

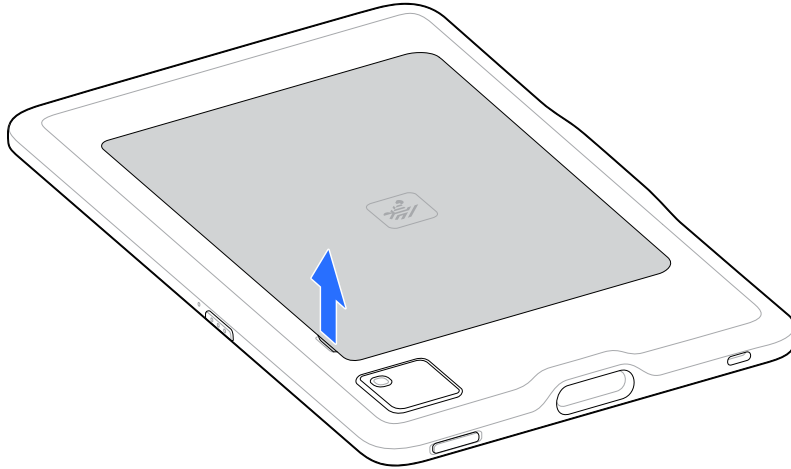

3. Place your thumb under the cover and slide your thumb along the short edge of the cover toward the other side.

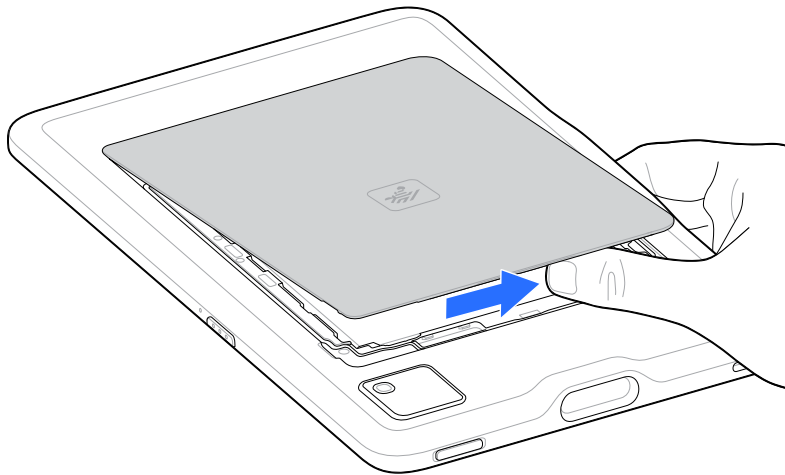

4. Carefully lift the edges of the cover, releasing the clips.

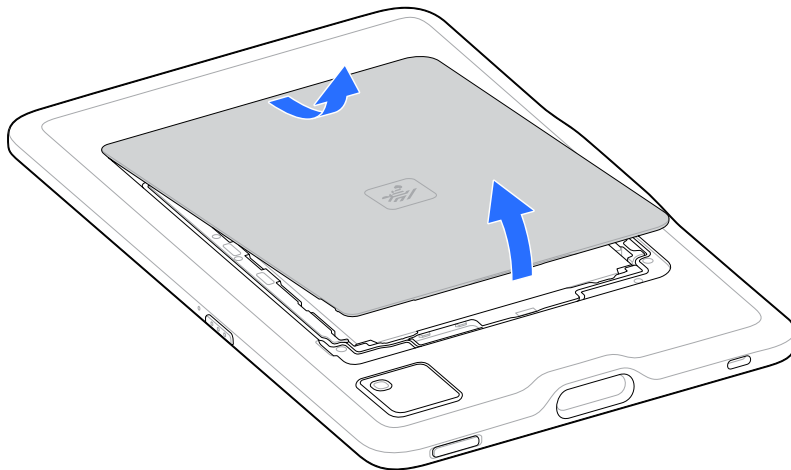

5. Remove the cover from the back housing.

- Using your fingernail, slide and hold the battery lock switch in the unlock position (1). While the switch is in the unlock position, lift the battery from the notched area (2), rotate the battery up, and then remove it from the battery well.

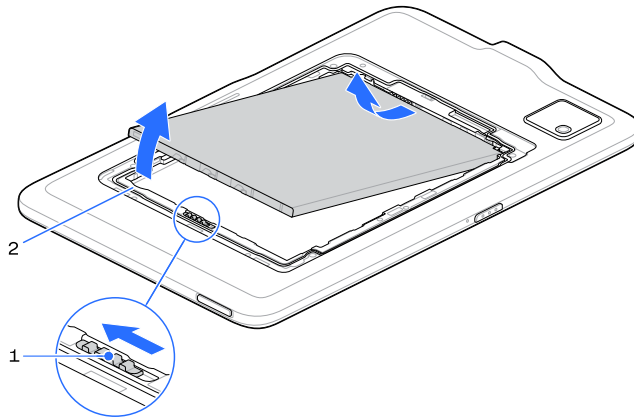

- After removing the battery from the device, release the battery lock switch.
- Pull the SIM/SD card drawer from the device.

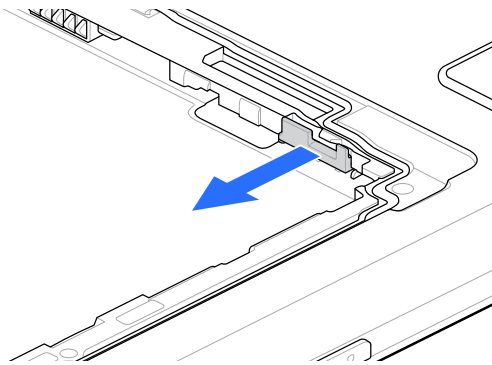

- Insert the microSD card on top of the tray(1), then insert the SIM card (2) at the bottom of the tray.



**NOTE:** Ensure the contacts for both cards are facing up.

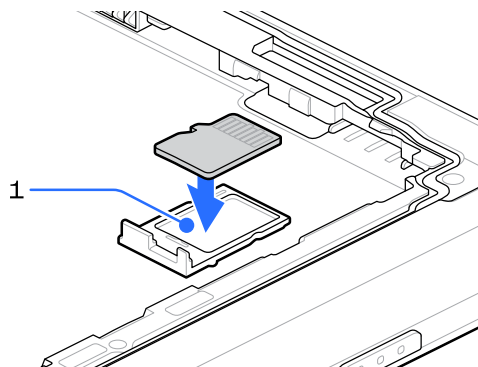

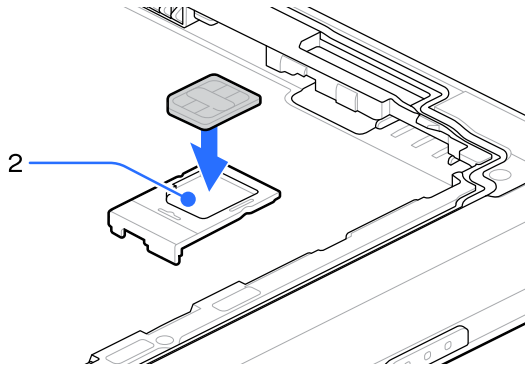

10. Ensure the proper orientation of the Nano SIM card and microSD card before inserting them into the drawer. Push the SIM/SD card drawer in and ensure it locks into place securely.

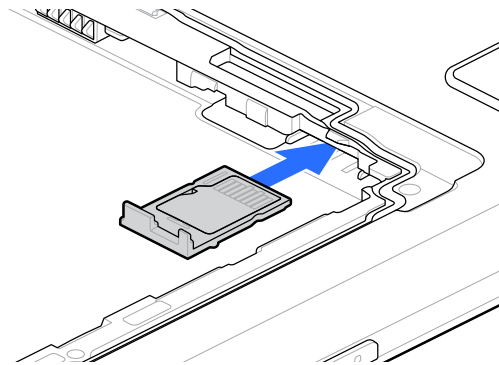
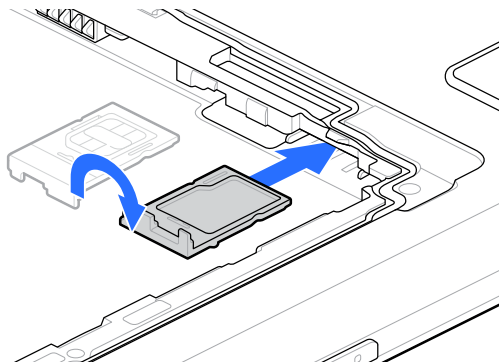

11. Replace the battery, contacts side first.

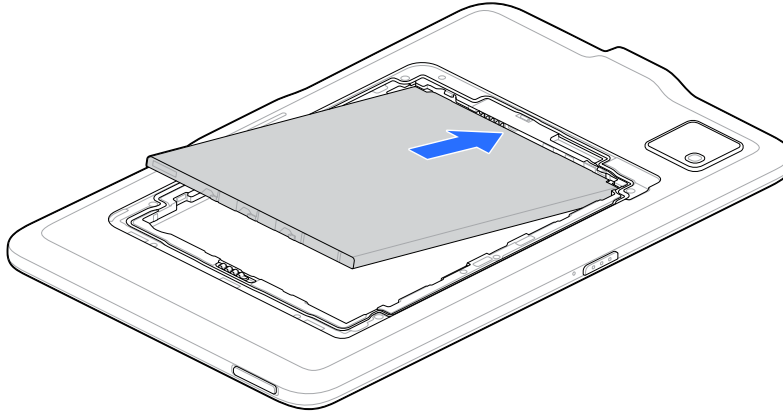

12. Gently push the battery towards the contacts while rotating it down into the battery well, ensuring it is seated properly.

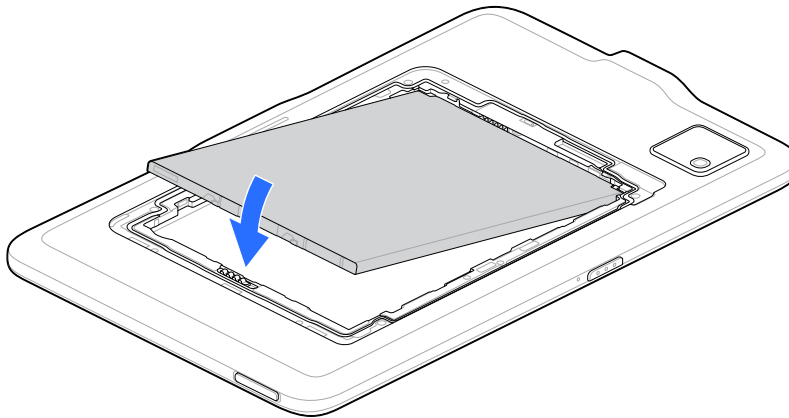

**CAUTION:** Ensure the battery cover is correctly oriented before replacement to prevent damage.

13. Insert the tabbed end of the battery cover into the slots in the battery well.
14. Rotate the cover down.

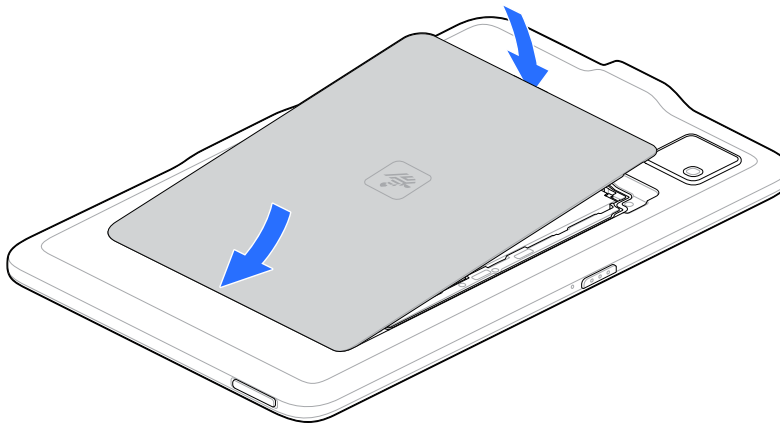

15. Carefully press down around the edges of the cover to ensure that it is seated properly.

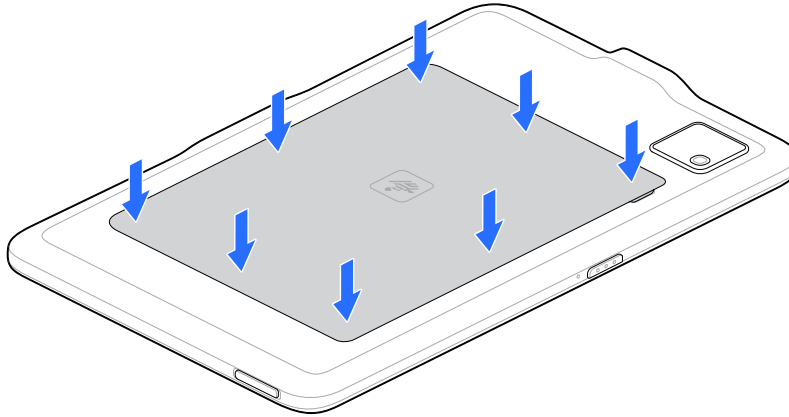

### Turning off the Display

To turn off the device display, press and release the Power button.

### Turning off the Device

This section provides information on how to turn off the device.



**NOTE:** After the device is powered off and external power is applied, the device will automatically power on. This includes powered cradles, an Expansion Back with a PowerPack, and a Rugged Charge Connector. However, when a power supply/USB-C cable is applied to a device that is powered off, the device will be in off-mode charging, where it remains in power off but charges the main battery.

1. Press and hold the Power button until the menu appears.
2. Touch **Power off**.

# Using the Device

This section explains how to use the device.

## Home Screen

Turn on the device to display the Home screen. Depending on how your system administrator configured your device, your Home screen may display differently than the graphics in this section.

After the device enters Sleep mode, the Home screen displays with the lock icon. Touch the screen and swipe up to unlock. The Home screen provides additional screens to place widgets and shortcuts. Touch and hold an icon, then drag it to place it on one of the other screens. Swipe left or right on the Home screen to view additional screens.



**NOTE:** By default, AOSP devices do not display the same icons on the Home screen as GMS devices. Icons shown are for illustrative purposes only

You can customize the Home screen icons and they may appear different from those shown.

**Figure 4** Home screen

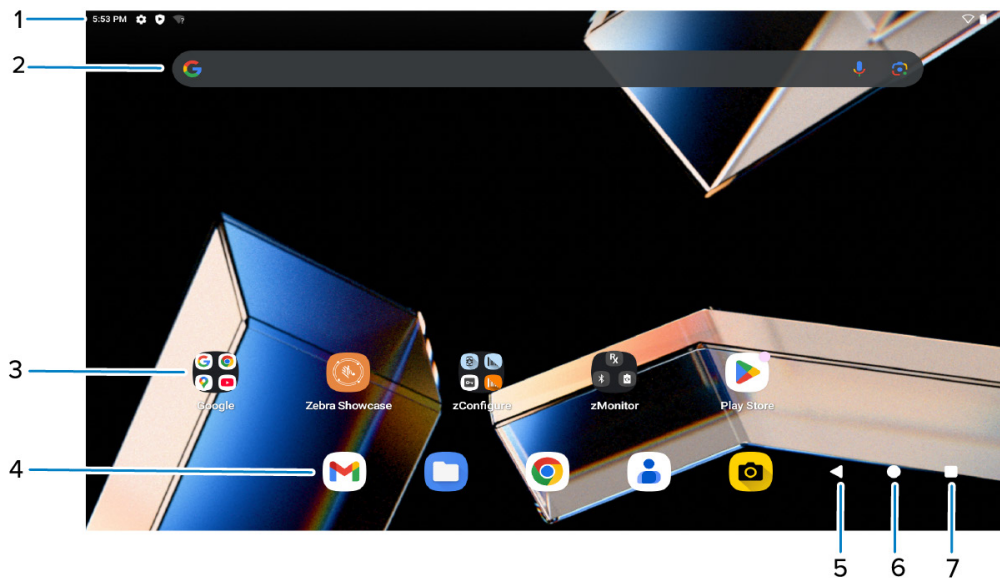

|   |                |   |
|---|----------------|---|
| 1 | Status bar     | Displays the time, status icons on the right side, and notification icons on the left side. |
| 2 | Widgets        | Launch stand-alone apps that run on the Home screen.  |
| 3 | Shortcut icons | Open apps installed on the device.  |
| 4 | Folder         | Contain apps.   |
| 5 | Back           | Display the previous screen.  |
| 6 | Home           | Display the Home screen.  |
| 7 | Recent         | Display recently used applications.   |

## Setting the Home Screen Rotation

By default, the device Home screen rotation is enabled.

1. Touch and hold anywhere on the Home screen until the options appear.
2. Touch **Home settings**.
3. Touch the **Allow home screen rotation** switch.
4. Touch **Home**.
5. Rotate the device to check.

## Status Bar

The Status bar displays the time, notification icons on the left side, and status icons on the right side.

If there are more notifications than can fit in the Status bar, a dot displays, indicating that more notifications exist. Swipe down from the Status bar to open the Notification panel and view all notifications and status icons.

**Figure 5** Notifications and Status Icons

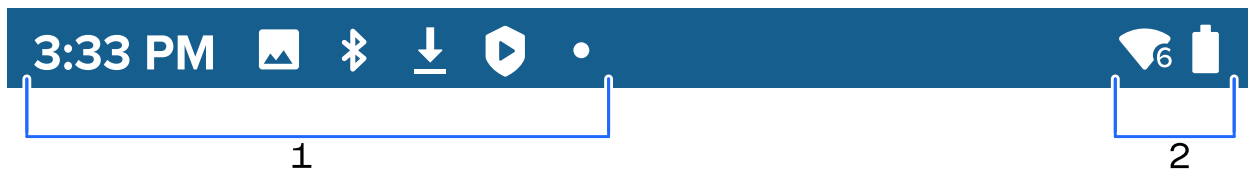

















|   |                    |
|---|--------------------|
| 1 | Notification icons |
| 2 | Status icons       |



## Notification Icons

The table lists the notification icons that display on the device status bar.

**Table 6** Notification Icons

| Icon  | Description  |
|---|--|
|    | Main battery is low.   |
|    | More notifications are available for viewing.                                |
|    | Data is syncing.   |
|    | Indicates an upcoming event. AOSP devices only.                              |
|    | Indicates an upcoming event. GMS devices only.                               |
|    | Open Wi-Fi network is available. The device is not connected to it.          |
|   | Audio is playing.  |
|  | Problem with sign-in or sync has occurred.                                   |
|  | Device is uploading data.  |
|  | Animated: the device is downloading data. Static: the download is complete.  |
|  | Device is connected to or disconnected from a virtual private network (VPN). |
|  | Preparing internal storage by checking it for errors.                        |
|  | USB debugging is enabled on the device.                                      |
|  | Wired headset with a boom module is connected to the device.                 |
|  | Wired headset without a boom module is connected to the device.              |
|  | Workcloud Sync client status.  |













**Table 6** Notification Icons (Continued)

| Icon  | Description  |
|---|--|
|  | Indicates the Bluetooth scanner is connected to the device.        |
|  | Indicates the ring scanner is connected to the device in HID mode. |







## Status Icons

Status icons display system information for the device.

**Table 7** Status Icons

| Icon  | Description   |
|---|---|
|    | Alarm is active.  |
|    | Main battery is fully charged.  |
|   | Main battery is partially drained.                                      |
|  | Main battery charge is low.   |
|  | Main battery charge is very low.  |
|  | Main battery is charging.   |
|  | UPS battery is fully charged.   |
|  | All sounds, except media and alarms, are muted. Vibrate mode is active. |
|  | Do Not Disturb mode active.   |
|  | Airplane Mode is active. All radios are turned off.                     |
|  | Bluetooth is on.  |
|  | Connected to a Bluetooth device.  |

**Table 7** Status Icons (Continued)

| Icon   | Description   |
|--|---|
|       | Connected to a Wi-Fi network. Indicates the Wi-Fi version number.<br><br> <b>NOTE:</b><br>Essential SKU supports only up to version 6. |
|       | Not connected to a Wi-Fi network or no Wi-Fi signal.  |
|       | Connected to an Ethernet network.   |
|       | Speakerphone enabled.   |
|       | Portable Wi-Fi hotspot is active.   |
| <b>4G<br/>LTE</b>  | Connected to a 4G LTE/LTE-CA network (WWAN only). <sup>a</sup>  |
| <b>5G</b>  | Connected to a 5G network (WWAN only).  |
| <b>4G</b>  | Connected to a DC-HSPA, HSDPA, HSPA+, HSUPA, LTE/LTE-CA or WCMDMA network (WWAN only). <sup>a</sup>   |
| <b>3G</b>  | Connected to a WCDMA network (WWAN only). <sup>a</sup>  |
| <b>H</b>   | Connected to a DC - HSPA, HSDPA, HSPA+ or HSUPA network (WWAN only). <sup>a</sup>   |
| <b>E</b>   | Connected to an EDGE network (WWAN only). <sup>a</sup>  |
| <b>G</b>   | Connected to a GPRS network (WWAN only). <sup>a</sup>   |
| <b>R<br/>↓↑</b>  | Roaming from a network (WWAN only).   |
|     | No SIM card installed (WWAN only).  |
| <sup>a</sup> Cellular network icon that appears is dependent upon the carrier/network. |   |

## Managing Notifications

Notification icons alert you to the arrival of new messages, calendar events, alarms, and ongoing events. When a notification occurs, an icon appears in the Status Bar along with a brief description.

**Figure 6** Notification Panel Portrait Mode

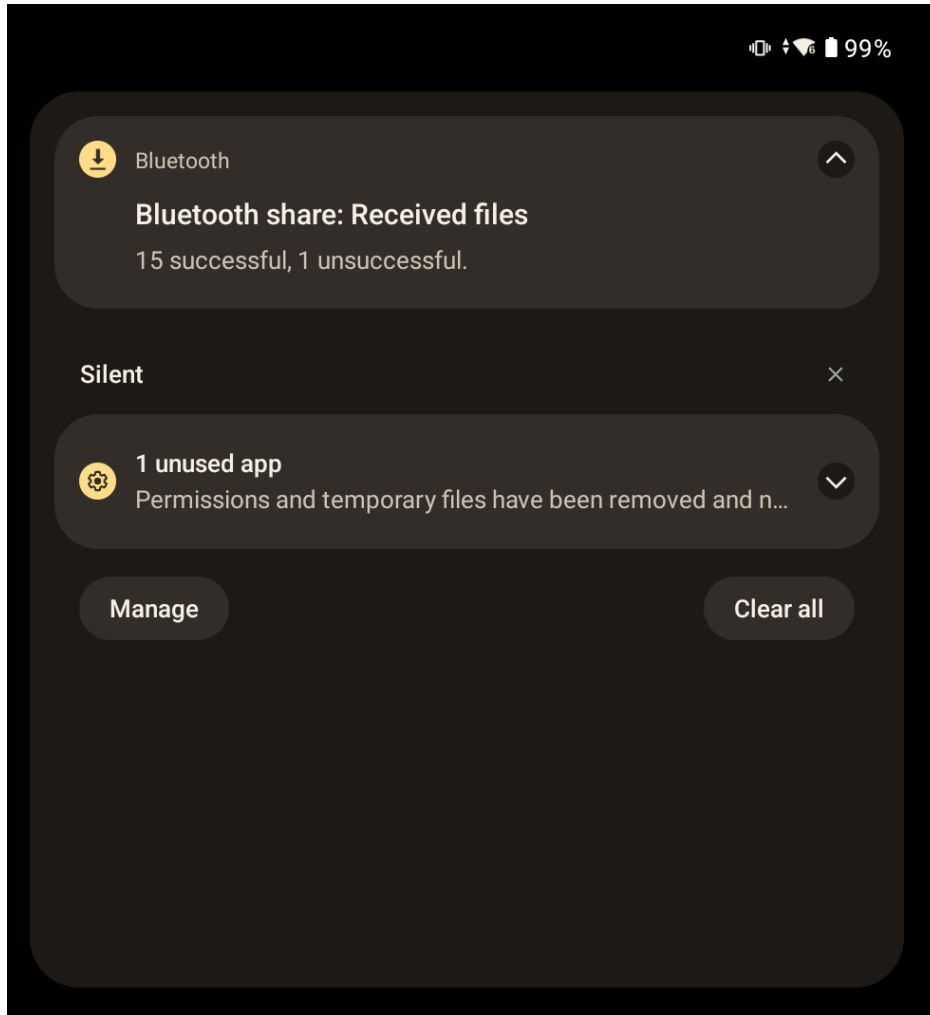
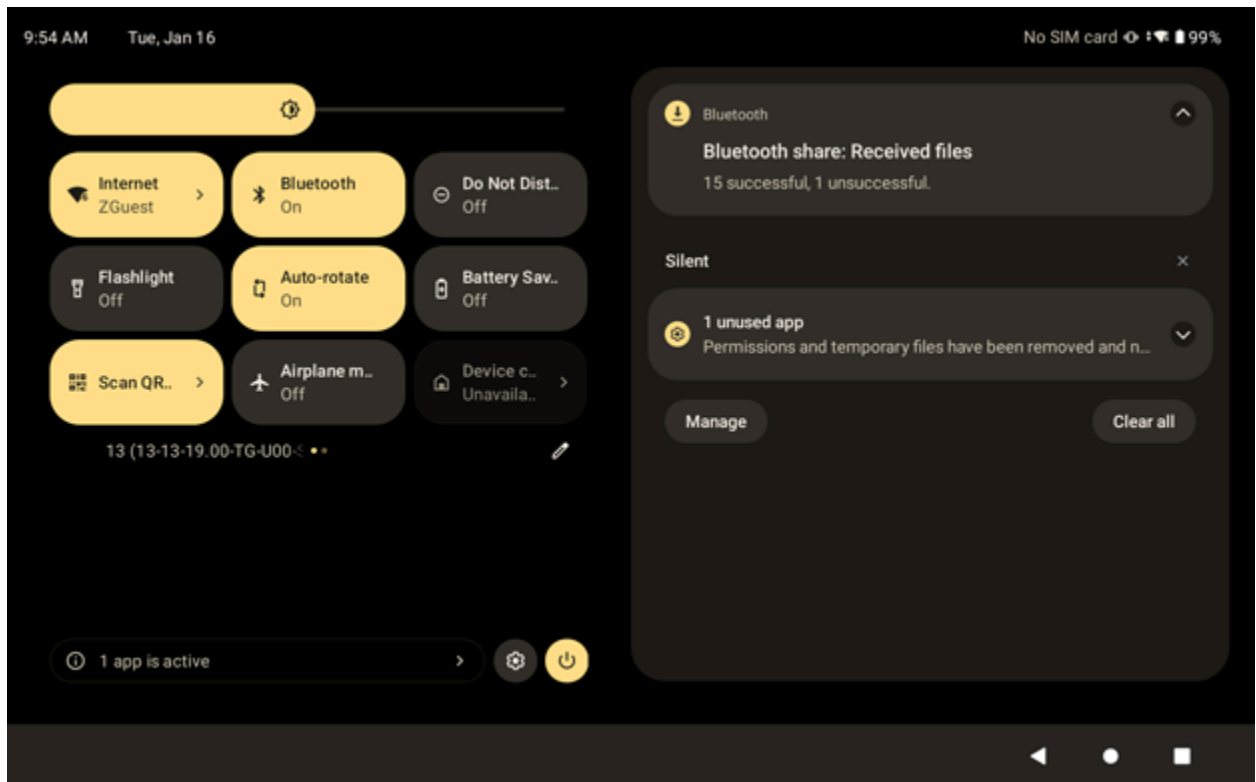

Figure 7 Notification Panel Landscape Mode



- To view a list of all notifications, open the Notification panel by dragging the Status bar down from the top of the screen.
- To respond to a notification, open the Notification panel and touch a notification. The Notification panel closes, and the corresponding app opens.
- To manage recent or frequently used notifications, open the Notification panel and touch **Manage > App notifications**. Toggle the switch next to an app to turn off all notifications for that app, or touch the app for more notification options.
- To clear all notifications, open the Notification panel and touch **Clear all**. All event-based notifications are removed, but ongoing notifications remain in the list.
- To close the Notification panel, swipe the panel up.

## Opening the Quick Access Panel

Use the Quick Access panel to access the frequently used settings (for example, Airplane mode).



**NOTE:** Not all icons are pictured. Icons may vary.

**Figure 8** Quick Access Panel

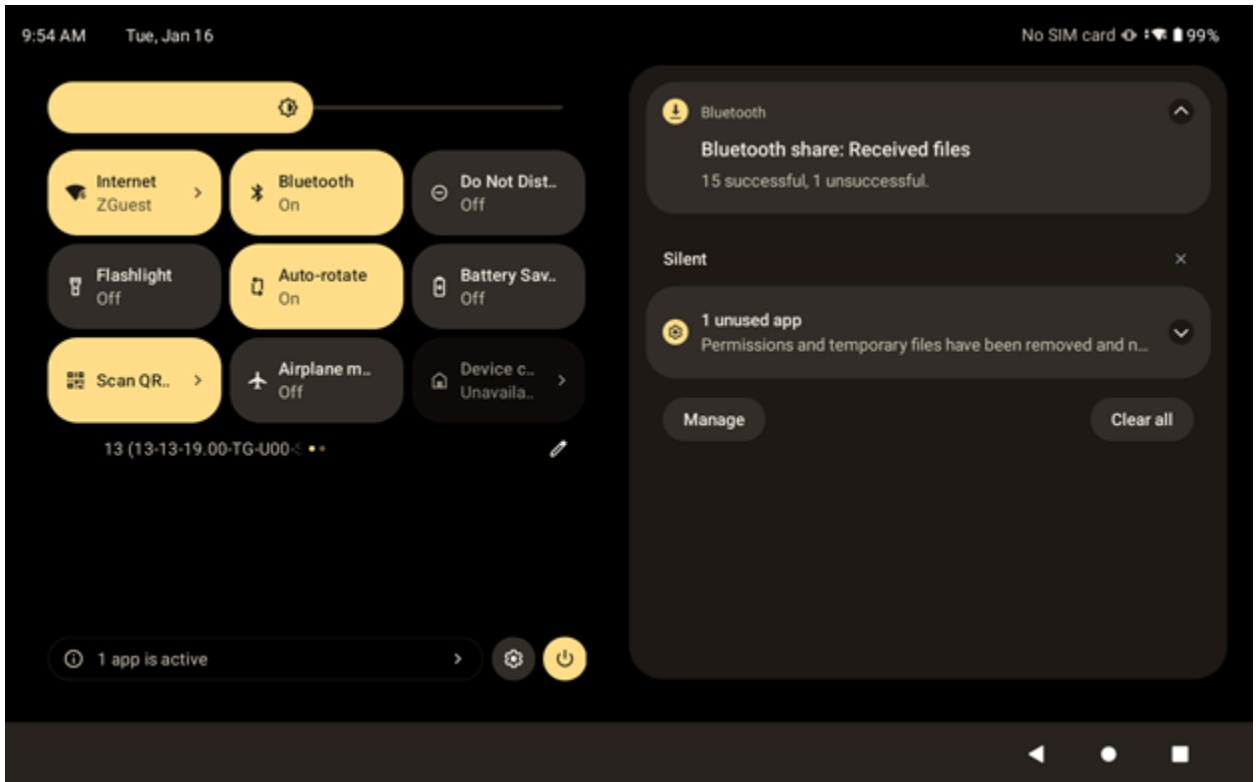





- Swipe down once to open the quick access panel.
- If the Notification panel is open, swipe down from the Quick Settings bar.















### Quick Access Panel Icons

The Quick Access panel icons indicate frequently used settings (for example, Airplane mode).













**Table 8** Quick Access Panel Icons

| Icon  | Description   |
|---|---|
|  | Display brightness - Use the slider to decrease or increase the brightness of the screen.   |
|  | Internet/Wi-Fi network - Turn Wi-Fi on or off. To open Wi-Fi settings, touch the Wi-Fi network name.  |
|  | Bluetooth settings - Turn Bluetooth on or off. To open Bluetooth settings, touch Bluetooth.   |
|  | Battery saver - Turn Battery saver mode on or off. When Battery saver mode is on the performance of the device is reduced to preserve battery power (not applicable). |

**Table 8** Quick Access Panel Icons (Continued)

| Icon  | Description  |
|---|--|
|    | Invert colors - Invert the display colors.   |
|    | Do not disturb - Control how and when to receive notifications.  |
|    | Mobile data - Enables or disables data transfer via the WAN. The device is still available for voice calls and texts. To open Mobile data settings, touch and hold (WWAN only).  |
|    | Airplane mode - Turn Airplane mode on or off. When Airplane mode is on the device does not connect to Wi-Fi or Bluetooth.  |
|    | Auto-rotate - Lock the device's orientation in portrait or landscape mode or set to automatically rotate.  |
|    | Flashlight - Turn the flashlight or camera flash on or off. When the flashlight is activated, it stays on unless it is turned off or the camera app is run.  |
|   | Location - Enable or disable locationing feature.  |
|  | Hotspot - Turn on to share the device's mobile data connection with other devices.   |
|  | Data saver - Turn on to prevent some apps from sending or receiving data in the background.  |
|  | Night light - Tint the screen amber to make it easier to look at the screen in dim light. Set Night Light to turn on automatically from sunset to sunrise, or at other times.  |
|  | Screen cast - Share phone content on Chromecast or a television with Chromecast built-in. On the Cast screen, check the "enable wireless display" option, and then touch "cast screen" to display a list of devices. Touch a device in the list to begin casting.  |
|  | Dark theme - Toggles dark theme on and off. Dark themes reduce the luminance emitted by the screen, while meeting minimum color contrast ratios. It helps improve visual ergonomics by reducing eye strain, adjusting brightness to current lighting conditions, and facilitating screen use in dark environments, while conserving battery power. |
|  | Focus mode - Turn on to pause distracting apps. To open Focus mode settings, touch and hold.   |
|  | Bedtime mode - Turn grayscale on and off. Grayscale turns the screen black and white, reducing phone distractions and improving battery life.  |
|  | Nearby share - Helps find and interact with services and devices close to the device.  |

**Table 8** Quick Access Panel Icons (Continued)

| Icon  | Description   |
|---|---|
|    | Screen record - Makes a video recording of everything that happens on the screen, with options to include audio and screen touches. |
|    | NFC - Enable or disable NFC communication.  |
|    | Wallet - Opens Android wallet.  |
|    | Alarm - Opens the Alarm app.  |
|    | Scan QR code - Opens the camera app for QR code reading.  |
|    | Mic access - Enables device microphone.   |
|    | Camera access - Enables access to the camera app.   |
|  | Extra dim - Reduces screen brightness up to 50%.  |
|  | Color correction - Enable to help your device compensate for color blindness.   |
|  | Storage - Opens the Files app.  |
|  | Live caption - Enables captions to appear for any media playing, regardless of the device's volume level.                           |
|  | Calculator - Open the calculator app.   |

## Editing the Quick Access Tiles

You can configure the Quick Access Panel tiles that display on the Notification panel.

Open the Quick Access Panel and touch  to edit, add, or remove tiles.

## Battery Management

Recommended battery optimization tips for the device.

- Set the screen to turn off after a short period of inactivity.
- Reduce screen brightness.
- Turn off all wireless radios when not in use.
- Turn off automatic syncing for Email, Calendar, Contacts, and other apps.
- Minimize the use of apps that keep the device from sleeping, for example, music and video apps.



**NOTE:** Before checking the battery charge level, remove the device from any power source (cradle or cable).

## Low Battery Notification

When the battery charge level drops below the threshold mentioned in the table, the device displays a notice to connect the device to power. Charge the battery using one of the charging accessories.

**Table 9** Low Battery Notification

| Charge Level Drops Below | Action   |
|--------------------------|--|
| 18%                      | You should charge the battery soon.                |
| 10%                      | You must charge the battery.                       |
| 4%                       | The device turns off. You must charge the battery. |

## Battery-less Operation

This feature is supported only on Standard and Premium SKUs.

The device can operate without the main battery when connected to a power source via:

- USB-C cable connected to a PD power supply. See [Accessories](#) for more information.
- Bottom pogo connector (Vehicle Docks)
- Back cover accessories (VESA cover, Presentation Stand cover)



**NOTE:** If you are using the Expansion Back with PowerPack accessory, a battery must be installed for the device to operate.

- A reliable, uninterrupted power source is required to maintain tablet functionality.
- Battery options in **Setting** is not available.
- The battery icon displays in the Status bar and always indicates 50%.

## Checking Battery Status

Check the battery status through the Battery Information settings, the Battery Manager app, or the quick access panel.

- Open **Settings** and touch **About tablet** > **Battery Information**. Or swipe up from the bottom of the screen and touch  to open the **Battery Manager** app.

**Battery present status** indicates if the battery is present.

**Battery level** lists the battery charge (as a percentage of fully charged).

- Swipe down from the status bar to open the quick access panel.

The **battery percentage** is displayed next to the battery icon.

## Monitoring Battery Usage

The Battery screen provides battery charge details and power management options to extend battery life. Different apps display different information. Some apps include buttons that open screens with settings to adjust power use.

1. Go to **Settings**.
2. Touch **Battery**.

To display battery information and power management options for a specific app:

3. Go to **Settings**.
4. Touch **Apps**.
5. Touch **See all apps**.
6. Touch an app.
7. Touch **App battery usage**.

## Interactive Sensor Technology

To take advantage of these device sensors, applications use API commands. Refer to the Google Android Sensor APIs for more information. For information on the Zebra Android EMDK, go to: [techdocs.zebra.com](http://techdocs.zebra.com)

The device contains sensors that monitor movement, orientation, and ambient light.

- Gyroscope - Measures angular rotational velocity to detect rotation of the device.
- Accelerometer - Measures the linear acceleration of movement to detect the orientation of the device.
- Digital Compass - The digital compass or magnetometer provides simple orientation in relation to the Earth's magnetic field. As a result, the device always knows which way is North so it can auto-rotate digital maps, depending on the physical orientation of the device.
- Light Sensor - Detects ambient light and adjusts the screen brightness.

## Waking the Device

The device goes into Sleep mode when you press **Power** or after a period of inactivity (set in the Display settings window).

1. To wake the device from Sleep mode, press **Power** or the configured wake-up sources.  
The Lock screen displays.
2. Swipe the screen up to unlock.
  - If the screen option is set to Swipe, the Home screen displays.

- If either the PIN or Password screen unlock feature is enabled, a prompt displays. Enter the PIN or password to unlock the device and move to the Home screen.
- If the Pattern screen unlock feature is enabled, the Pattern screen displays. Swipe the correct pattern between the dots to unlock the device and move to the Home screen.



**NOTE:** If you enter the PIN, password, or pattern incorrectly five times, you must wait 30 seconds before trying again.

## USB Communication

Connect the device to a host computer to transfer files between the device and the host computer.

When connecting the device to a host computer, follow the host computer's instructions for connecting and disconnecting USB devices to avoid damaging or corrupting files.

When transferring files or debugging, ensure only one USB connection to the device exists. For example, do not dock the device or attach an expansion back if using a USB cable.

### Transferring Files

Use Transfer files to copy files between the device and the host computer.

1. Connect the device to a host computer using a USB accessory.
2. On the device, pull down the Notification panel and touch **Charging this device via USB**.

By default, **No data transfer** is selected.

3. Touch **File Transfer**.



**NOTE:** After changing the setting to **File Transfer**, and then disconnecting the USB cable, the setting reverts back to **No data transfer**. If the USB cable is reconnected, select **File Transfer** again.

4. On the host computer, open **File Explorer**.
5. Locate the **device** as a portable device.
6. Open the **Internal storage** folder.
7. Copy files to and from the device or delete files as required.

### Transferring Photos

Use PTP to copy photos from the device to the host computer.

1. Connect the device to a host computer using a USB accessory.
2. On the device, pull down the Notification panel and touch **Charging this device via USB**.
3. Touch **PTP**.
4. On the host computer, open a file explorer application.
5. Open the SD card or the Internal storage folder.
6. Copy or delete photos as required.

### Disconnecting from the Host Computer

When disconnecting the device from the host computer, ensure you unmount the device.



**CAUTION:** Carefully follow the host computer's instructions to disconnect USB devices correctly to avoid losing information.

1. On the host computer, unmount the device.
2. Remove the device from the USB accessory.

# Settings

This section describes the settings on the device.

## Accessing Settings

There are multiple ways to access settings on a device.

- Swipe down from the top of the Home screen to open the Quick Access panel and touch .
- Swipe up from the bottom of the Home screen to open APPS and touch **Settings**.

## Display Settings

Use Display settings to change the screen brightness, enable night light, change the background image, enable screen rotation, set screen timeout, enable dark theme, and change font size.

### Setting the Screen Brightness Automatically

Automatically adjust the screen brightness using the built-in light sensor.

1. Go to **Settings > Display**.
2. Touch **Adaptive brightness** to toggle the feature on or off.

When enabled, the screen brightness automatically adjusts to your environment and activities.

### Setting the Screen Brightness Manually

Manually set the screen brightness using the touchscreen.

1. Swipe down from the Status bar to open the Quick Access panel.
2. Slide  left or right to adjust the screen brightness level.

### Setting Night Light

The Night Light setting tints the screen amber, making the screen easier to look at in low light.

1. Go to **Settings**.
2. Touch **Display**.

3. Touch **Night Light**.
4. Touch **Schedule**.
5. Select one of the schedule values:
  - **None** (default)
  - **Turns on at custom time**
  - **Turns on from sunset to sunrise**
6. By default, **Night Light** is disabled. Touch **Use Night Light** to enable.
7. Adjust the tint using the **Intensity** slider.

### Setting Screen Rotation

By default, the screen rotation is enabled.

1. Go to **Settings**.
2. Touch **Accessibility > System controls**.
3. Touch **Auto-rotate screen**.
4. Touch **Home**.

### Setting Screen Timeout

The screen turns off and goes into system sleep mode after the selected period of inactivity.

1. Go to **Settings**.
2. Touch **Display > Screen timeout**.
3. Select one of the system sleep values:
  - **15 seconds**
  - **30 seconds**
  - **1 minute** (default)
  - **2 minutes**
  - **5 minutes**
  - **10 minutes**
  - **30 minutes**

### Setting Lock Screen Notifications

The lock screen display setting wakes the screen when notifications are received.

1. Go to **Settings**.
2. Touch **Display**.
3. Touch **Lock screen**.
4. You can enable or disable an option using the toggle switch.

## Setting Font and Display Size

Set the size of the font and display in system apps.

1. Go to **Settings**.
2. Touch **Display**.
3. Touch **Display size and text**.
4. Use the size + and - slider to vary the size of the font and the display accordingly.

## Setting Touch Panel Mode

The display is able to detect touches using a finger, a fiber-tipped stylus, a plastic stylus, or a gloved finger.



**NOTE:** A glove can be made of medical latex, leather, cotton, or wool. For optimal performance, use a Zebra-certified stylus.

1. Go to **Settings**.
2. Touch **Display**.
3. Touch **Touch panel mode**.
4. Select:
  - **Finger Only** to use a finger (no gloves) on the screen.
  - **Stylus, Glove, and Finger** to use a stylus (plastic stylus only), gloved finger, or a finger on the screen.
5. Touch **Home**.



**NOTE:** For Standard and Premium SKUs, the Stylus, Glove and Finger option is selected by default, and no manual selection is required.

## Setting the Date and Time

The date and time are automatically synchronized using a NITZ server when the device is connected to a cellular/wireless network. You are only required to set the time zone or set the date and time if the wireless LAN does not support Network Time Protocol (NTP) or when not connected to a cellular/wireless network.

1. Go to **Settings**.
2. Touch **System > Date & time**.
3. Touch **Set time automatically** to disable automatic date and time synchronization.
4. Touch **Set automatically** to disable automatic time zone synchronization.
5. Touch **Date** to select the date in the calendar.
6. Touch **OK**.
7. Touch **Time**.
  - a) Touch the circle, drag to the current hour, and then release.
  - b) Touch the circle, drag to the current minute, and then release.
  - c) Touch **AM** or **PM**.

8. Touch **OK**.
9. Touch **Time zone** to select the current time zone from the list.
10. Touch **Update Interval** to select an interval to synchronize the system time from the network.
11. Under Time Format, choose either **Use locale default** or **Use 24-hour format**.

## General Sound Setting

Press the volume buttons on the device to display on-screen volume controls.

Use the Sound settings to configure media and alarm volumes.

1. Go to **Settings**.
2. Touch **Sound & vibration**.
3. Touch an option to set sounds.

## Sound Options

The Sound Options menu allows users to customize and manage their device's audio and vibration settings to suit their preferences.

- **Zebra volume controls:**
  - **Media volume** - Controls the music, games, and media volume.
  - **Call volume** - Controls the volume during a call.
  - **Ring volume** - Controls the ringtone volume.
  - **Notification volume** - Controls the notification volume.
  - **Alarm volume** - Controls the alarm clock volume.
  - **Do Not Disturb** - Mutes some or all sounds and vibrations.
  - **Live Caption** - Automatically caption speech.
  - **Media** - Shows the media player in Quick Settings while sound is playing, allowing quick access.
- **Vibration & haptics:**
  - **Ring vibration** - Vibrate the device when the phone rings.
  - **Notification vibration** - Vibrate the device when a notification comes in.
  - **Alarm vibration** - Vibrate the device when an alarm goes off.
  - **Touch feedback** - Vibrate the device when making screen selections.
  - **Media vibration** - Enable vibration when using a media player.
- **Default notification sound** - Select a sound to play for all system notifications.
- **Default alarm sound** - Select a sound to play for alarms.
- **Screen locking sound** - Play a sound when locking and unlocking the screen (default - enabled).
- **Charging sounds and vibration** - Play a sound and vibrate when power is applied to the device (default - enabled).
- **Tap & click sounds** - Play a sound when interacting with the screen (default - enabled).

- **Always show icon when in vibrate mode** - Enable the vibrate mode status bar icon.

### Zebra Volume Controls

In addition to the default sound settings, Zebra Volume Controls display when the volume buttons are pressed.

Zebra Volume Controls are configured using Audio Volume UI Manager (AudioVolUIMgr). Administrators can use AudioVolUIMgr to add, delete and replace Audio Profiles, select an Audio Profile to use the device, and modify the default Audio Profile. For information on how to configure Zebra Volume Controls using AudioVolUIMgr, go to [techdocs.zebra.com](https://techdocs.zebra.com).

### Remapping a Button

Buttons on the device can be programmed to perform different functions or as shortcuts to installed apps. For a list of key names and descriptions, refer to: [techdocs.zebra.com](https://techdocs.zebra.com)

1. Go to **Settings**.
2. Touch **Key Programmer**. A list of programmable buttons displays.
3. Select the button to remap.
4. Touch the **SHORTCUT**, the **KEYS and BUTTONS**, or the **TRIGGER** tabs that list the available functions, applications, and triggers.
5. Touch a function or application shortcut to map to the button.



**NOTE:** If you select an application shortcut, the application icon appears next to the button on the Key Programmer screen.

6. Touch **Home**.

## Remappable Keys

Buttons on the device can be remapped for various functions.

**Figure 9** Key Positions

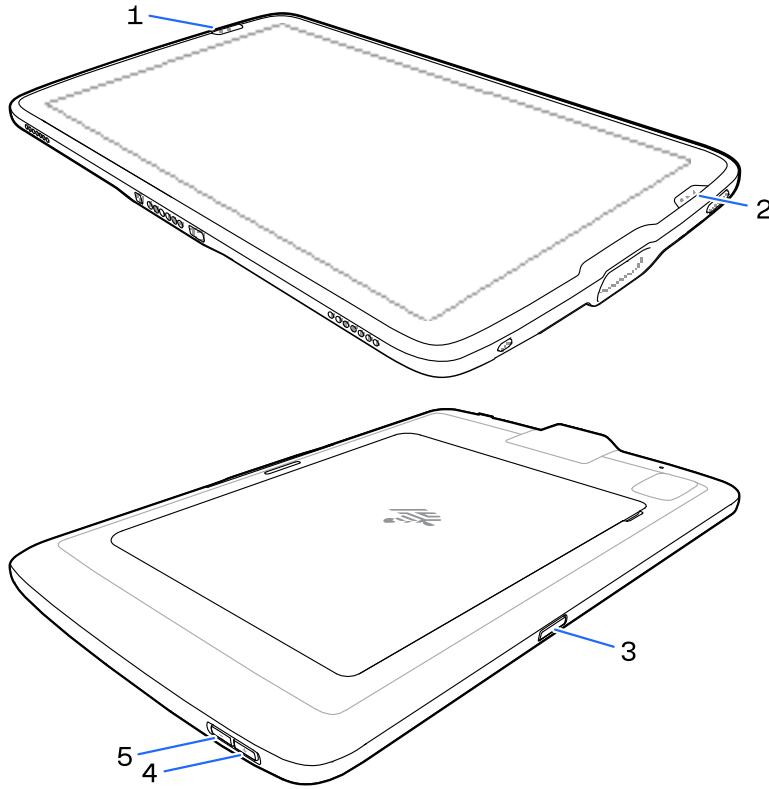

|   |                          |
|---|--------------------------|
| 1 | SCAN                     |
| 2 | P1                       |
| 3 | RIGHT_TRIGGER_1          |
| 4 | VOLUMEUP                 |
| 5 | VOLUMEDOWN               |
|   | GRIP_TRIGGER (not shown) |

## Keyboards

The device provides multiple keyboard options.



**NOTE:** The Enterprise Keyboard is available for download from the [Zebra Support Site](#).

- Android Keyboard - AOSP devices only
- Gboard - GMS devices only
- Enterprise Keyboard - Not pre-installed on the device. Contact Zebra Support for more information.

## Enabling Keyboards

This section describes how to enable keyboards.

1. Go to **Settings**.
2. Touch **System** > **Keyboard** > **On-screen keyboard**.
3. Touch a keyboard to enable.

## Switching Between Keyboards

When multiple keyboards are enabled, you can switch between them to access different settings and characters.



**NOTE:** By default, the Gboard is enabled. All other virtual keyboards are disabled.

1. Touch a text box to display the current keyboard.
2. Touch the keyboard icon in the lower-left corner of the screen.
3. Select a keyboard from the **Choose input method** dialog.

## Using the Keyboards

Using the keyboards to enter text in a text field.

- To configure the keyboard settings, touch and hold "," (comma) and then select **Android keyboard settings**.

### Edit Text

Edit entered text and use menu commands to cut, copy, and paste text within or across apps. Some apps do not support editing some or all of the text they display; others may offer their own way to select text.

### Entering Numbers, Symbols, and Special Characters

This section describes how to input numbers, symbols, and special characters using the keyboard.

1. Enter numbers and symbols.
  - Touch and hold one of the top-row keys until a menu displays then select a number or special character.
  - Touch the Shift key once for a single capital letter. Touch the Shift key twice to lock in uppercase. Touch the Shift key a third time to unlock Capslock.
  - Touch **?123** to switch to the numbers and symbols keyboard.
  - Touch the **=\<** key on the numbers and symbols keyboard to view additional symbols.
2. Enter special characters.
  - Touch and hold a number or symbol key to open a menu of additional symbols. A larger version of the key displays briefly over the keyboard.

## Enterprise Keyboard

The Enterprise Keyboard contains multiple keyboard types.



**NOTE:** Only available with Mobility DNA Enterprise License.

- Numeric
- Alpha
- Special characters
- Data capture

## Numeric Tab

The numeric keyboard is labeled **123**. The keys displayed vary on the app being used. For example, an arrow displays in **Contacts**, however **Done** displays in **Email** account setup.

## Alpha Tab

The alpha keyboard is labeled using the language code. For English, the alpha keyboard is labeled **EN**.

## Additional Character Tab

The additional characters keyboard is labeled **#\*!**.

- Touch 😊 to enter emoji icons in a text message.
- Touch **ABC** to return to the Symbols keyboard.

## Scan Tab

The Scan tab provides an easy data capture feature for scanning barcodes.

## Language Usage

Use the **Language & input** settings to change the device's language, including words added to the dictionary.

### Changing the Language Setting

This section describes how to change the language setting.

1. Go to **Settings**.
2. Touch **System > Languages**.
3. Touch **System Languages**.  
A list of available languages displays.
4. If the desired language is not listed, touch **Add a language** and select a language from the list.

5. Touch and hold the  icon that is located to the right of the newly added language, then drag it to the top of the list.

The operating system text changes to the selected language.

### Adding Words to the Dictionary

This section describes how to add words to the device's dictionary.

1. Go to **Settings**.
2. Touch **System > Keyboard > Personal dictionary**.
3. If prompted, select the language where this word or phrase is stored.
4. Touch **+** to add a new word or phrase to the dictionary.
5. Enter the word or phrase.
6. In the **Shortcut** text box, enter a shortcut for the word or phrase.

### Notifications

Device notification settings allow you to configure how notifications occur on the device, and app notification settings allow you to configure how notifications for a specific app occur.

To view device notification settings, touch **Settings > Notifications**.

To view app notifications, touch **Settings > Notifications > App notifications**, and then select an app.

### Enabling Blink Light

The Notification LED lights are blue when an app, such as email and VoIP, generates a programmable notification or to indicate when the device is connected to a Bluetooth device. By default, LED notifications are enabled.

1. Go to **Settings**.
2. Touch **Notifications**.
3. Touch **Blink light** to toggle the notification on or off.

# Applications

The APPS screen displays icons for all installed apps. Go to [Application Deployment](#) for information on installing and uninstalling apps. For information on standard Android apps, refer to the Google Play Store (<https://play.google.com/store/apps>).

## Installed Applications

Aside from the common Google apps, the Zebra-specific apps that are installed on the device are described in this section.

Table 10 Apps















| Item  | Description  |
|---|--|
|  | <b>Battery Manager</b> - Display battery information (including charge level, status, health, and wear level) and use to place the device in Battery Swap mode when replacing the battery. |
|  | <b>Bluetooth Pairing Utility</b> - Use to pair a Zebra Bluetooth scanner with the device by scanning a barcode.  |
|  | <b>Camera</b> - Take photos or record videos.  |
|  | <b>DataWedge</b> - Enables data capture using the imager.  |
|  | <b>DisplayLink Desktop</b> - Use to present the device screen onto a connected monitor.  |
|  | <b>DWDemo</b> - Provides a way to demonstrate the data capture features using the imager.  |
|  | <b>License Manager</b> - Use to manage software licenses on the device.  |

Table 10 Apps (Continued)

| Item  | Description  |
|---|--|
|    | <b>Phone</b> - Use to dial a phone number when used with some Voice over IP (VoIP) clients (VoIP telephony ready only).  |
|    | <b>Settings</b> - Use to configure the device.   |
|    | <b>StageNow</b> - Allows the device to stage a device for initial use by initiating the deployment of settings, firmware, and software.  |
|    | <b>VoD</b> - The Video on Device basic app provides a how-to video for proper device cleaning. For Video on Device licensing information, contact <a href="mailto:learningservices@zebra.com">learningservices@zebra.com</a> .   |
|    | <b>Wireless Analyzer</b> - A diagnostic intelligent app. Use to diagnose surrounding area and display network stats, such as coverage hole detection or AP in the vicinity. Refer to the Worry Free Wi-Fi Analyzer Administrator Guide for Android. Only available with Mobility DNA Enterprise License. |
|   | <b>Zebra Bluetooth Settings</b> - Use to configure Bluetooth logging.  |
|  | <b>Zebra Data Services</b> - Use to enable or disable Zebra Data Services. Some options are set by the system administrator.   |

## Accessing Apps

Access all apps installed on the device using the APPS window.

1. On the Home screen, swipe up from the bottom of the screen.
2. Slide the **APPS** window up or down to view more app icons.
3. Touch an icon to open the app.

## Switching Between Recent Apps

On the device, you can switch between open applications.

1. Touch **Recent**.  
A window displays with a list of recently used applications.
2. Slide the apps left or right to view all the apps.
3. Swipe up to remove the app from the list and force close the apps.
4. Touch an app or touch **Back** to return to the current screen.

## Battery Manager

The Battery Manager provides detailed information about the battery.

This section also provides battery swap procedures for supported devices.

### Opening Battery Manager



This section describes the method for opening the Battery Manager app.

- To open the Battery Manager app, swipe up from the bottom of the Home screen, and then touch .

### Battery Manager Information

The Battery Manager displays detailed information about battery charging, health, and status.

**Table 11** Battery Icons

| Battery Icon  | Description                                   |
|---|---|
|    | Battery charge level is between 85% and 100%. |
|    | Battery charge level is between 19% and 84%.  |
|  | Battery charge level is between 0% and 18%.   |

- Level** - The current battery charge level as a percentage. Displays -% when the level is unknown.
- Wear** - The health of the battery in graphical form. When the wear level exceeds 80%, the bar color changes to yellow.
- Health** - The health of the battery. If a critical error occurs,  displays. An error description is visible within the app.
  - Decommission** - The battery is past its useful life and should be replaced. See system administrator.
  - Good** - The battery is good.
  - Charge error** - An error occurred while charging. See system administrator.
  - Over Current** - An over-current condition occurred. See system administrator.
  - Dead** - The battery has no charge. Replace the battery.
  - Over Voltage** - An over-voltage condition occurred. See system administrator.
  - Below Temperature** - The battery temperature is below the operating temperature. See system administrator.
  - Failure Detected** - A failure has been detected in the battery. See system administrator.
  - Unknown** - See system administrator.
- Charge Status**
  - Not charging** - The device is not connected to AC power.

## Applications

- **Not charging** - The device is not charging.
- **Charging-AC** - The device is connected to AC power and charging or is fast charging via USB.
- **Charging-USB** - The device is connected to a host computer with a USB cable and charging.
- **Discharging** - The battery is discharging.
- **Full** - The battery is fully charged.
- **Unknown** - The battery status is unknown.
- **Time until Full** - The amount of time until the battery is fully charged.
- **Time since charging** - The amount of time since the device began charging.
- **Time until empty** - The amount of time until the battery is empty.
- **Advanced info** - Additional battery information.
  - **Battery present status** - Indicates that the battery is present.
  - **Battery level** - The battery charge level as a percentage of scale.
  - **Battery scale** - The battery scale level used to determine battery level (100).
  - **Scaled Battery Level** - The charge level as a percentage of full capacity.
  - **ZCM Status** - The current status of the Zero Current Mode, power-saving mode.
  - **Battery voltage** - The current battery voltage in millivolts.
  - **Battery temperature** - The current battery temperature in degrees Centigrade.
  - **Battery technology** - The type of battery.
  - **Battery current** - The average current into or out of the battery over the last second in mAh.
  - **Battery manufacture date** - The date of manufacture.
  - **Battery serial number** - The battery serial number. The number matches the serial number printed on the battery label.
  - **Battery part number** - The battery part number.
  - **Battery decommission status** - Indicates if the battery is past its life span.
    - **Battery Good** - The battery is in good health.
    - **Decommissioned Battery** - The battery is past its useful life and should be replaced.
  - **Base cumulative charge** - Cumulative charge using Zebra charging equipment only.
  - **Battery present capacity** - Maximum amount of charge that could be pulled from the battery under the present discharge conditions if the battery were fully charged.
  - **Battery health percentage** - With a range from 0 to 100, this is the ratio of "present\_capacity" to "design\_capacity" at a discharge rate of "design\_capacity".
  - **% decommission threshold** - The default % decommission threshold for a gifted battery as 80%.
  - **Battery present charge** - Amount of usable charge remaining in the battery at present under the current discharge conditions.
  - **Battery total cumulative charge** - The total accumulated charge in all chargers.
  - **Battery time since first use** - The time passed since the battery was placed in a Zebra terminal for the first time.

- **Battery error status** - The error status of the battery.
- **App version** - The application version number.

## Camera

This section provides information for taking photos and recording videos using the integrated digital cameras.

### Taking Photos

Use the device camera to take photos.



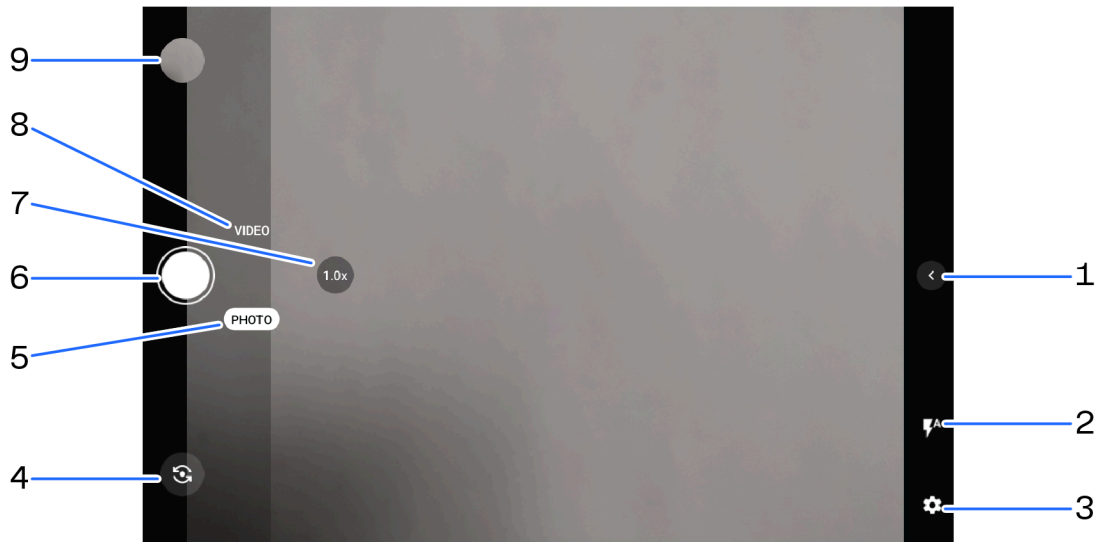

**NOTE:** See [Camera Settings](#) for camera settings descriptions.

1. Swipe up from the bottom of the Home screen and touch **Camera**.



|   |   |
|---|---|
| 1 | Quick settings  |
| 2 | Flash (rear camera only)  |
| 3 | Settings  |
| 4 | Camera switch   |
| 5 | Photo mode  |
| 6 | Camera shutter button   |
| 7 | Quick zoom button (1.0x, 2.0x)<br> <b>NOTE:</b> Press and hold to use the zoom slider from 1.0x to 8.0x. |
| 8 | Video mode  |
| 9 | Gallery   |

2. Select **PHOTO** mode.
3. To switch between the rear camera and front camera (if available), touch .
4. Frame the subject on the screen.
5. To zoom in or out, use two fingers to pinch and expand or use the Quick Zoom button.
6. Touch an area on the screen to focus. The focus rectangle appears.
7. Touch .

## Recording Videos

Record videos using the device camera.





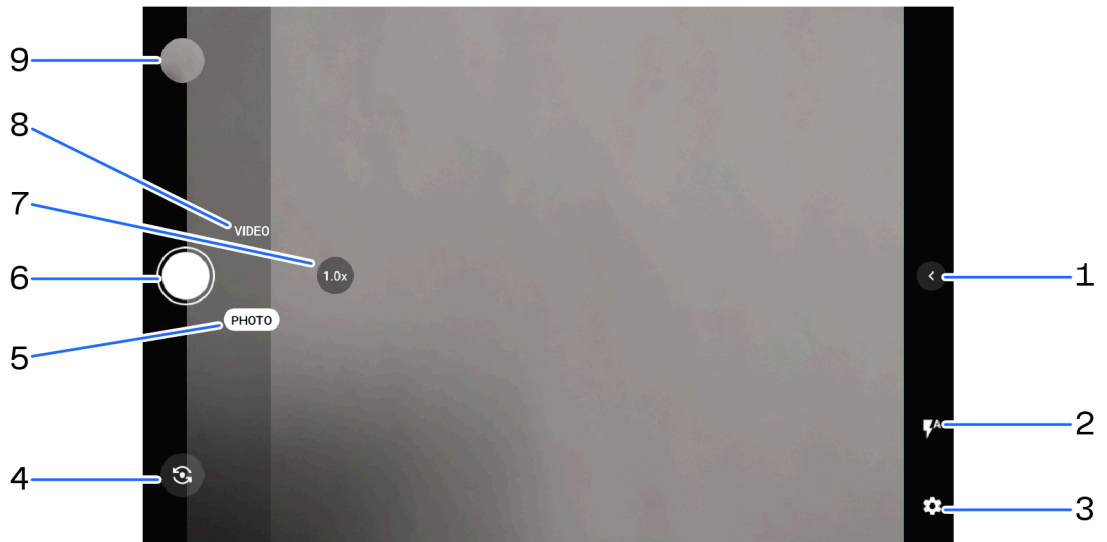

**NOTE:** See [Camera Settings](#) for camera settings descriptions.

1. Swipe up from the bottom of the Home screen and touch **Camera**.





|   |                                      |
|---|--------------------------------------|
| 1 | Quick settings                       |
| 2 | Flash (rear camera only)             |
| 3 | Settings                             |
| 4 | Camera switch                        |
| 5 | Photo mode                           |
| 6 | Camera shutter button                |
| 7 | Quick zoom button (1.0x, 2.0x, 3.0x) |
| 8 | Video mode                           |

2. Select **VIDEO** mode.

3. To switch between the rear camera and front camera (if available), touch .
4. Point the camera and frame the scene.
5. To zoom in or out, use two fingers to pinch and expand or use the Quick Zoom button.
6. Touch  to start recording.  
The video time appears at the top of the screen.
7. Touch  to take a photo of the recording.
8. Touch  to end the recording.

### Camera Settings

In Photo mode, camera settings appear on the screen. Touch  >  to display the camera settings options. Settings vary depending on whether the front or rear camera is active.

- **General** - These settings apply to both the still camera and video camera.
  - **Camera Sounds** - Select to play a shutter sound when taking a photo. Options: Disable or Enable (default).
  - **Haptic Feedback** - Provides tactile responses when interacting with the camera.
  - **Location Tags** - Includes location information when pictures and videos are taken.
  - **Storage** - Set the location to store the photo to: Phone or SD Card.
  - **Dirty Lens Detection** - Notifies when the camera lens might be dirty. Options: Disable (default) or Enable.
  - **QR Code Mode** - Enable to scan QR Codes with the option to launch URL. Options: Disable (default) or Enable.
  - **Google Lens** - Select to enable Google-developed recognition technology that brings up relevant information related to identified objects within an image.
  - **Digital Level** - Display a level line to ensure the photo or video is level. Options: Disable (default) or Enable.
  - **Face Detection** - Select to turn the face detection On (default) or Off.
  - **Gestures** - View gestures and power user controls. Gestures include: Swipe Down, Swipe Up, Side Swipe, Tap, Tap + Hold, Double Tap, and Hold Zoom.
- **Still Camera** - These settings apply only to the still camera.
  - **Photo Grid** - Displays a 3 x 3 grid guide on the camera viewport. Options: Disabled (default), or Enable.
  - **Countdown timer** - Select Off (default), 3 seconds, or 10 seconds.
  - **Picture size** - The size (in pixels) of the photo: 8M pixels, 5M pixels (front camera default), HD720, WVGA, VGA, or QVGA.
  - **Picture quality** - Set the picture quality setting to: Low, Standard, or High (default).
  - **Image Quality Analyzer** - Analyzes the image quality for the degree of sharpness.
  - **Privacy Blur - Face Blur** - Identify faces in any captured photo and blur them out.

- **Picture Format** - All still images are saved in JPEG format.
- **MFNR** - Sets multi-frame noise reduction to improve quality in low light conditions. Options: Enabled (default), or Disabled.
- **AutoFocus Animation** - Select to enable or disable the camera focus ring in the camera preview. Options: Disable (default) or Enable.
- **Video Camera** - These settings apply only to the video camera.
  - **Video quality** - Set video quality to: 4k UHD (rear camera only), HD 1080p (default), HD 720p, SD 480p, VGA, CIF, or QVGA.
  - **Video duration** - Set to: 30 seconds (MMS), 10 minutes (default), 30 minutes, or no limit.
  - **Noise Reduction** - Off, Fast, or High Quality (default).
  - **HEVC Encoder** - Save video recordings using high-efficiency video codec (HEVC/h265) for smaller file size. Options: Disabled (default), or Enable.
  - **Audio Encoder** - Set the audio encoder to: AMRNB, or AAC (default).
  - **Video Rotation** - Set the rotation of the video to: 0 (default), 90, 180, or 270.
- **System**
  - **Restore defaults** - Select to restore all settings to the default values.
  - **About** - Displays the software version of the camera app.

## Camera Preview Size Limitation

Due to a limitation in the camera preview resolution, the device supports a maximum resolution of 1600x1200 in the camera viewfinder preview mode.

For Standard SKUs, the default preview size is 1440x1080, and for the Value SKUs, the default preview size is 1600x1200.

## DWDemo

Use DataWedge Demonstration (DWDemo) to demonstrate data capture functionality on the device. To configure DataWedge, refer to [techdocs.zebra.com](http://techdocs.zebra.com)





**NOTE:** DataWedge is enabled on the Home screen. To disable this feature, go to the DataWedge settings and disable the **Launcher** profile.









## DWDemo Icons

This table lists the icons available on the device DWDemo app.

**Table 12** DataWedge Demonstration Icons

| Category     | Icon  | Description  |
|--------------|---|--|
| Illumination |  | Imager illumination is on. Touch to turn illumination off. |
| Illumination |  | Imager illumination is off. Touch to turn illumination on. |

**Table 12** DataWedge Demonstration Icons (Continued)

| Category     | Icon  | Description   |
|--------------|---|---|
| Data capture |    | Indicates a USB scanner is connected to the device.   |
| Data capture |    | Indicates a USB scanner is not connected to the device.                                       |
| Data Capture |    | The data capture function is through the internal imager or USB scanner.                      |
| Data capture |    | The data capture function is through the rear camera.   |
| Data capture |    | A Bluetooth scanner is connected.   |
| Data capture |    | A Bluetooth scanner is not connected.   |
| Scan mode    |    | Imager is in picklist mode. Touch to change to normal scan mode.                              |
| Scan mode    |   | Imager is in normal scan mode. Touch to change to picklist mode.                              |
| Menu         |  | Opens a menu to view the application information or to set the application DataWedge profile. |

## Selecting a Scanner

Select one of the scanning options available on the device.

See the [Data Capture](#) section for more information.

1. To select a scanner, touch  > **Settings** > **Scanner Selection**.
2. Press the programmable button or touch the yellow scan button to capture data.  
The data displays in the text field below the yellow button.

# Data Capture

This section provides information for capturing barcode data using various scanning options on the device.

- SE4100 Internal Imager
- SR500 Internal Imager
- Camera
- RS507/RS507X
- RS5100
- RS6000
- DS2278
- DS3678
- DS8178
- LI3678

## Imaging

The device with an integrated 2D imager has the following features:

- Omnidirectional reading of a variety of barcode symbologies, including the most popular linear, postal, PDF417, Digimarc, and 2D matrix code types.
- The ability to capture and download images to a host for a variety of imaging applications.
- Advanced intuitive laser aiming cross-hair and dot aiming for easy point-and-shoot operation.

The imager uses imaging technology to take a picture of a barcode, stores the resulting image in memory, and executes state-of-the-art software decoding algorithms to extract the barcode data from the image.

## Scanning Considerations

Typically, scanning is a simple matter of aim, scan, and decode, with a few quick trial efforts to master it.

However, consider the following to optimize scanning performance:

- Range — Scanners decode optimally over a particular working range — minimum and maximum distances from the barcode. This range varies according to barcode density and scanning device

optics. Scan within range for quick and constant decodes; scanning too close or too far away prevents decodes. Move the scanner closer and further away to find the right working range for the barcodes being scanned.

- Angle — Scanning angle is important for quick decodes. When the illumination/flash reflects directly back into the imager, the specular reflection can blind/saturate the imager. To avoid this, scan the barcode so that the beam does not bounce directly back. Do not scan at too sharp an angle; the scanner needs to collect scattered reflections from the scan to make a successful decode. Practice quickly shows what tolerances to work within.
- Hold the device farther away for larger symbols.
- Move the device closer for symbols with bars that are close together.



**NOTE:** Scanning procedures depend on the app and device configuration. An app may use different scanning procedures from the one listed above.

### Scanning with an Internal Scanner

Use the internal scanner to capture barcode data.



**NOTE:** To read a barcode, a scan-enabled app is required. The device contains the DataWedge app that allows you to enable the scanner to decode barcode data and display the barcode content.

1. Ensure that an app is open on the device and a text field is in focus (text cursor in the text field).
2. Point the exit window of the device at a barcode.

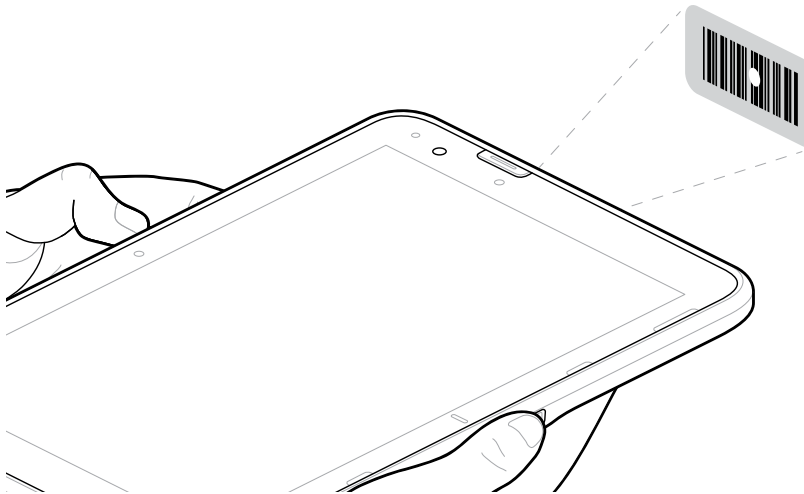

3. Press and hold one of the scan buttons.

The aiming dot with illumination turns on to assist in aiming.



**NOTE:** In Pick List Mode, which is enabled by default, the device only decodes the barcode when the center of the aiming dot touches the barcode.

4. Ensure the barcode is within the area formed by the aiming pattern.

The Data Capture LED lights green and a beep sounds to indicate the barcode was decoded successfully.

## Scanning with the Camera

Use the device internal camera to capture barcode data.



**NOTE:** To read a barcode, a scan-enabled app is required. The device contains the DataWedge app that allows you to enable the scanner to decode barcode data and display the barcode content.



**NOTE:** The integrated camera is intended for light-duty barcode scanning. For heavy-duty scanning, 100 or more scans per day, use the 2D imager.

When capturing barcode data in poor lighting, turn on Illumination mode in the DataWedge application.

To scan with the internal camera:

1. Launch a scanning application.
2. Point the camera window at a barcode.

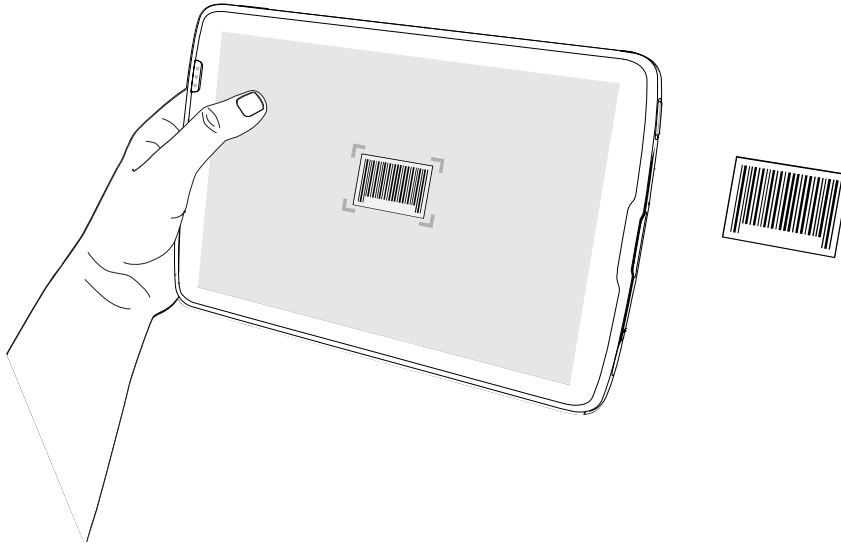

3. Press and hold the scan button. By default, a preview window displays on the screen.
4. Move the device until the barcode is visible on the screen.
5. If Picklist mode is enabled, move the device until the barcode is centered under the aiming dot on the screen.

The Decode LED lights green, a beep sounds and the device vibrates, by default, to indicate the barcode is decoded successfully.

The captured data appears in the text field.

## Scanning with the RS507/RS507X Hands-Free Imager

Use the RS507/RS507X Hands-Free Imager to capture barcode data.

**Figure 10** RS507/RS507X Hands-Free Imager



Refer to the RS507/RS507X Hands-free Imager Product Reference Guide for more information.



**NOTE:** To read a barcode, a scan-enabled app is required. The device contains the DataWedge app that allows you to enable the scanner to decode barcode data and display the barcode content.

To scan with the RS507/RS507x:

1. Pair the RS507/RS507X with the device.
2. Ensure that an app is open on the device and a text field is in focus (text cursor in text field).
3. Point the RS507/RS507X at a barcode.

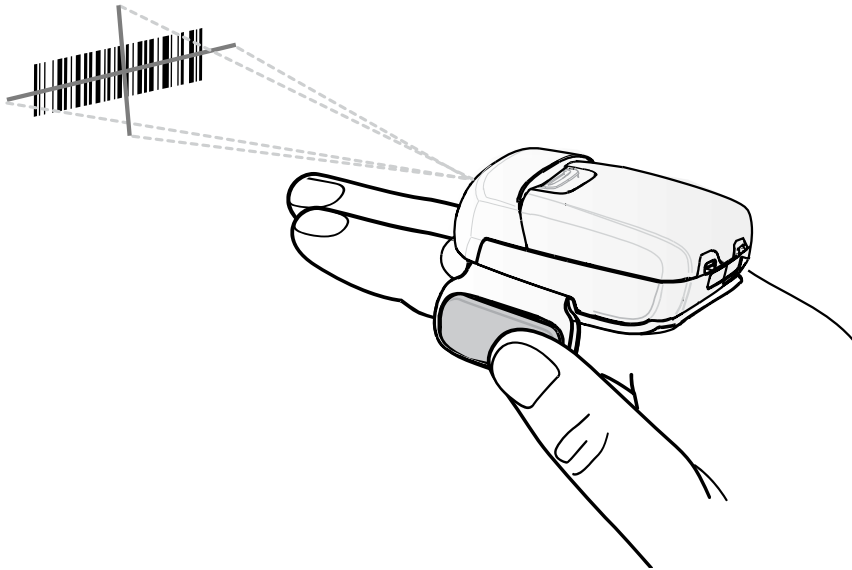

4. Press and hold the trigger.

The red laser aiming pattern turns on to assist in aiming. Ensure the barcode is within the area formed by the cross-hairs in the aiming pattern. The aiming dot increases visibility in bright lighting conditions.

**Figure 11** RS507/RS507X Aiming Pattern

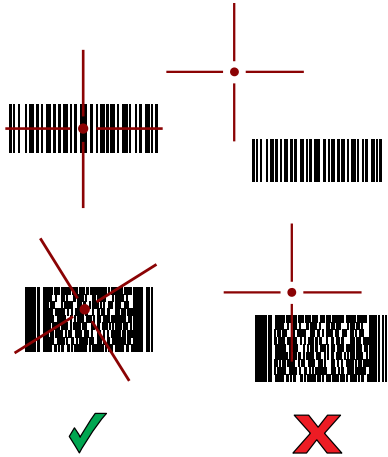

When the RS507/RS507X is in Pick List mode, the RS507/RS507X does not decode the barcode until the center of the crosshair touches the barcode.

**Figure 12** RS507/RS507X Pick List Mode with Multiple Barcodes in Aiming Pattern

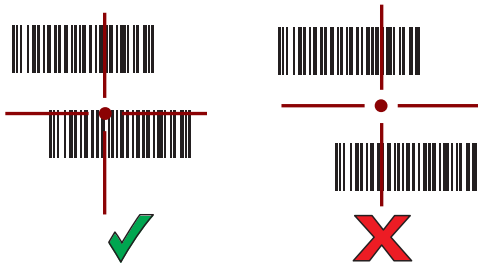

The RS507/RS507X LEDs light green and a beep sounds to indicate the barcode was decoded successfully.

The captured data appears in the text field.

## Scanning with the RS5100 Ring Scanner

Use the RS5100 Ring Scanner to capture barcode data.

**Figure 13** RS5100 Ring Scanner

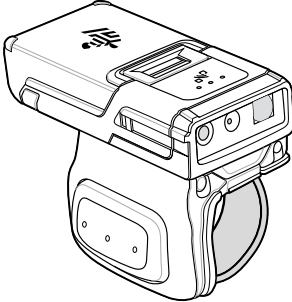

Refer to the RS5100 Ring Scanner Product Reference Guide for more information.



**NOTE:** To read a barcode, a scan-enabled app is required. The device contains the DataWedge app that allows you to enable the scanner to decode barcode data and display the barcode content.

To scan with the RS5100:

1. Pair the RS5100 with the device.
2. Ensure that an app is open on the device and a text field is in focus (text cursor in text field).
3. Point the RS5100 at a barcode.

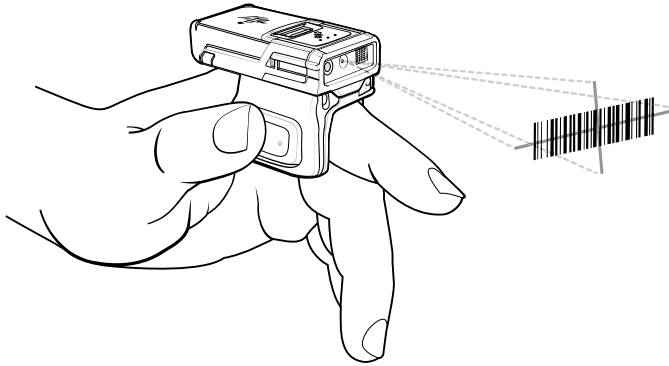

4. Press and hold the trigger.

The red laser aiming pattern turns on to assist in aiming. Ensure the barcode is within the area formed by the cross-hairs in the aiming pattern. The aiming dot increases visibility in bright lighting conditions.

**Figure 14** RS5100 Aiming Pattern

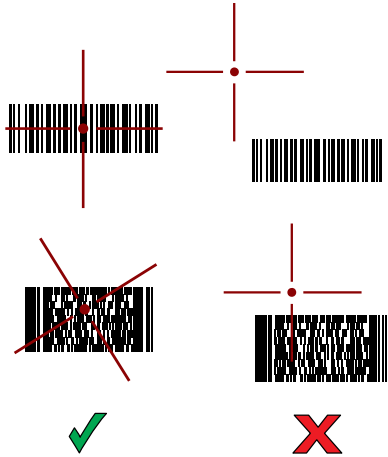

When the RS5100 is in Pick List mode, the RS5100 does not decode the barcode until the center of the crosshair touches the barcode.

**Figure 15** RS5100 Pick List Mode with Multiple Barcodes in Aiming Pattern

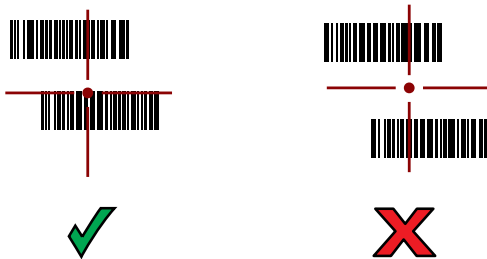

The RS5100 LEDs light green and a beep sounds to indicate the barcode was decoded successfully. The captured data appears in the text field.

## Scanning with the RS6000 Bluetooth Ring Scanner

Use the RS6000 Bluetooth Ring Scanner to capture barcode data.

**Figure 16** RS6000 Bluetooth Ring Scanner

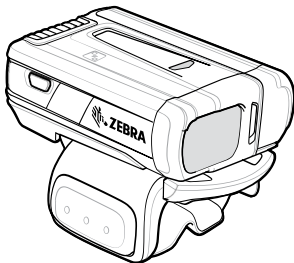

Refer to the RS6000 Bluetooth Ring Scanner Product Reference Guide for more information.



**NOTE:** To read a barcode, a scan-enabled app is required. The device contains the DataWedge app that enables you to use the scanner to decode barcode data and display the barcode content.

To scan with the RS6000:

1. Pair the RS6000 with the device.
2. Ensure that an app is open on the device and a text field is in focus (text cursor in text field).
3. Point the RS6000 at a barcode.

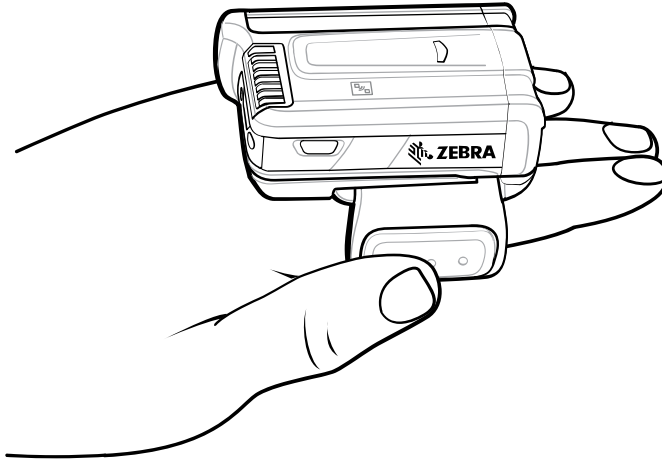

4. Press and hold the trigger.

The red laser aiming pattern turns on to assist in aiming. Ensure the barcode is within the area formed by the cross-hairs in the aiming pattern. The aiming dot increases visibility in bright lighting conditions.

**Figure 17** RS6000 Aiming Pattern

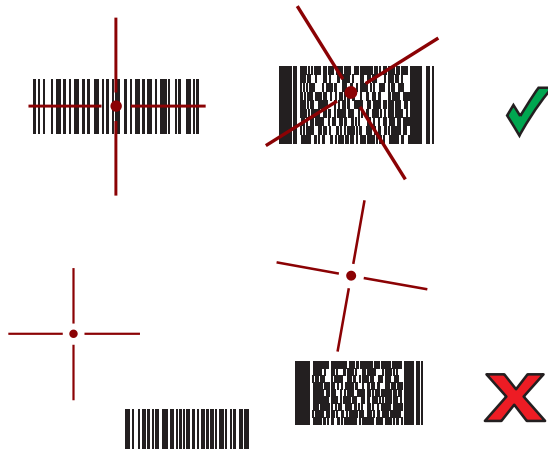

When the RS6000 is in Pick List mode, the RS6000 does not decode the barcode until the center of the crosshair touches the barcode.

**Figure 18** RS6000 Pick List Mode with Multiple Barcodes in Aiming Pattern



The RS6000 LEDs light green and a beep sounds to indicate the barcode was decoded successfully. The captured data appears in the text field.

## Scanning with the RS6100 Bluetooth Ring Scanner

Use the RS6100 Bluetooth Ring Scanner to capture barcode data.

**Figure 19** RS6100 Bluetooth Ring Scanner



Refer to the RS6100 Bluetooth Ring Scanner Product Reference Guide for more information.



**NOTE:** To read a barcode, a scan-enabled app is required. The device contains the DataWedge app that allows the user to enable the scanner to decode barcode data and display the barcode content.

To scan with the RS6100:

1. Pair the RS6100 with the device.
2. Ensure that an app is open on the device and that a text field is in focus (text cursor in text field).
3. Point the RS6100 at a barcode.
4. Press and hold the trigger.

The green laser aiming pattern turns on to assist in aiming. Ensure the barcode is within the area formed by the cross-hairs in the aiming pattern. The aiming dot increases visibility in bright lighting conditions.

**Figure 20** RS6100 Aiming Pattern



When the RS6100 is in Pick List mode, the RS6100 does not decode the barcode until the center of the crosshair touches the barcode.

**Figure 21** RS6000 Pick List Mode with Multiple Barcodes in Aiming Pattern

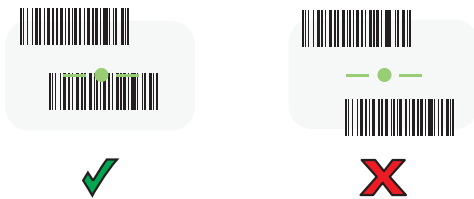

The RS6100 LEDs light green and a beep sounds to indicate the barcode was decoded successfully. The captured data appears in the text field.

## Scanning with the DS2278 Digital Scanner

Use the DS2278 Digital Scanner to capture barcode data.

**Figure 22** DS2278 Digital Scanner



Refer to the DS2278 Digital Scanner Product Reference Guide for more information.



**NOTE:** To read a barcode, a scan-enabled app is required. The device contains the DataWedge app that allows you to enable the scanner to decode barcode data and display the barcode content.

To scan with the DS2278:

1. Pair the DS2278 with the device. See [Pairing a Bluetooth Scanner](#) for more information.
2. Ensure that an app is open on the device and a text field is in focus (text cursor in text field).
3. Point the scanner at a barcode.

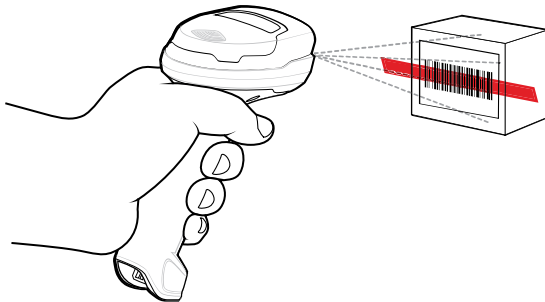

4. Press and hold the trigger.
5. Ensure the aiming pattern covers the barcode.



6. Upon successful decode, the scanner beeps and the LED flashes, and the scan line turns off. The captured data appears in the text field.

## Scanning with the DS3678 Bluetooth Scanner

Use the DS3678 Bluetooth Scanner to capture barcode data.

**Figure 23** DS3678 Digital Scanner

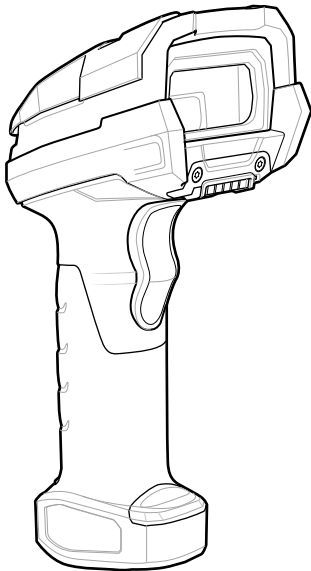

Refer to the DS3678 Product Reference Guide for more information.



**NOTE:** To read a barcode, a scan-enabled app is required. The device contains the DataWedge app that allows you to enable the scanner to decode barcode data and display the barcode content.

To scan with the DS3678 scanner:

1. Pair the scanner with the device. See [Pairing Bluetooth Scanners](#) for more information.
2. Ensure that an app is open on the device and a text field is in focus (text cursor in text field).
3. Point the scanner at a barcode.

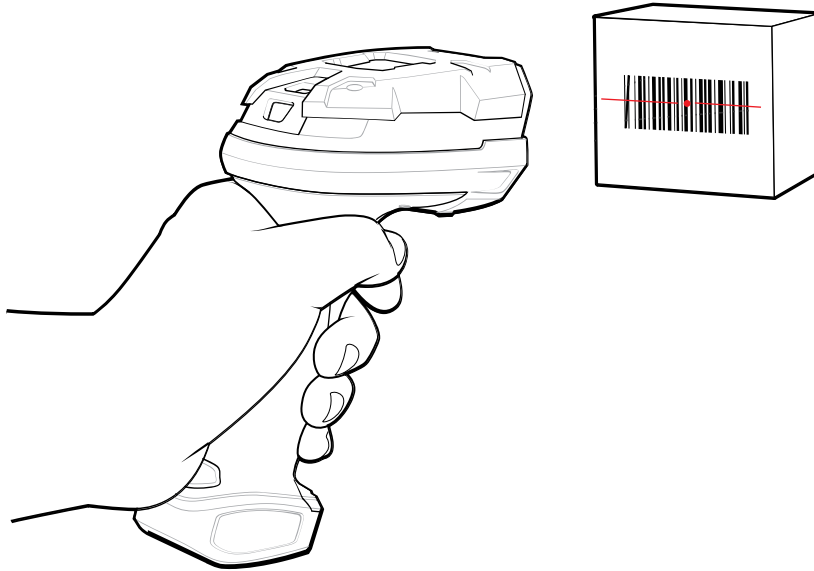

**4. Press and hold the trigger.**

Ensure the barcode is within the area formed by the aiming pattern. The aiming dot increases visibility in bright lighting conditions.

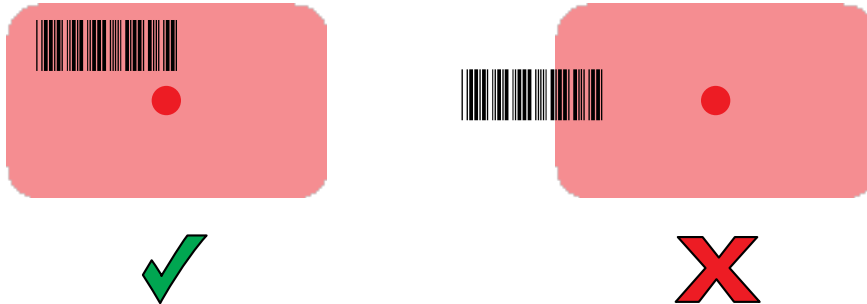

The captured data appears in the text field.

## Scanning with the DS8178 Digital Scanner

Use the DS8178 Bluetooth Scanner to capture barcode data.

**Figure 24** DS8178 Digital Scanner

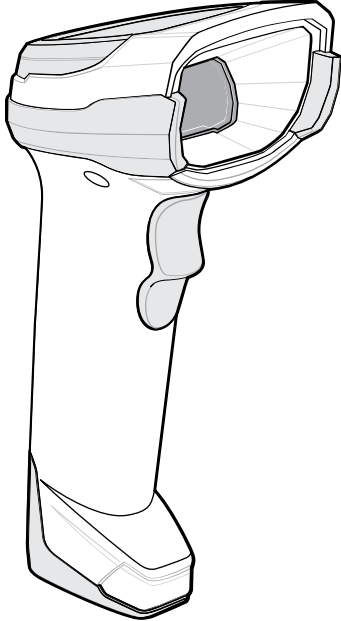

Refer to the DS8178 Digital Scanner Product Reference Guide for more information.



**NOTE:** To read a barcode, a scan-enabled app is required. The device contains the DataWedge app that allows you to enable the scanner to decode barcode data and display the barcode content.

To scan with the DS8178 scanner:

1. Pair the scanner with the device. See [Pairing Bluetooth Scanners](#) for more information.
2. Ensure that an app is open on the device and a text field is in focus (text cursor in text field).
3. Point the scanner at a barcode.

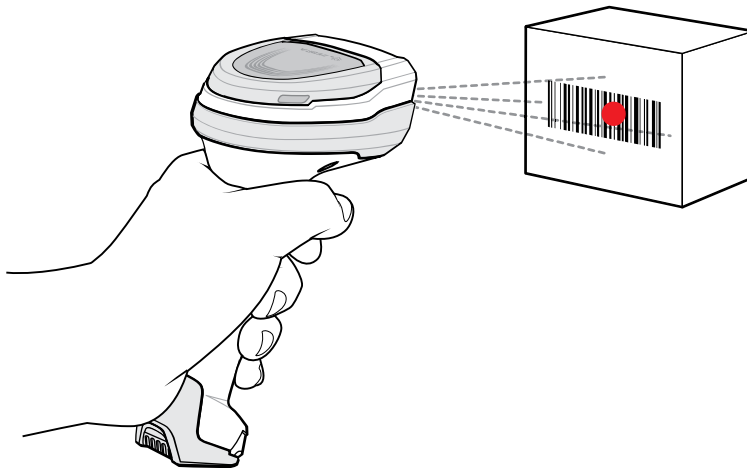

4. Press and hold the trigger.

5. Ensure the barcode is within the area formed by the aiming pattern. The aiming dot increases visibility in bright lighting conditions.

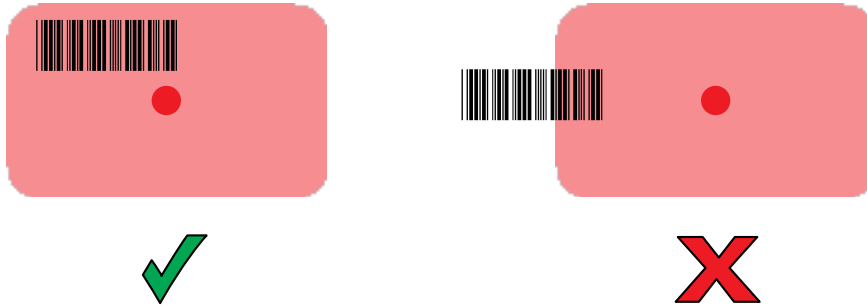

6. Upon successful decode, the scanner beeps and the LED flashes, and the scan line turns off. The captured data appears in the text field.

### Scanning with the LI3678 Linear Imager

Use the LI3678 linear imager to capture barcode data.

**Figure 25** LI3678 Bluetooth Scanner

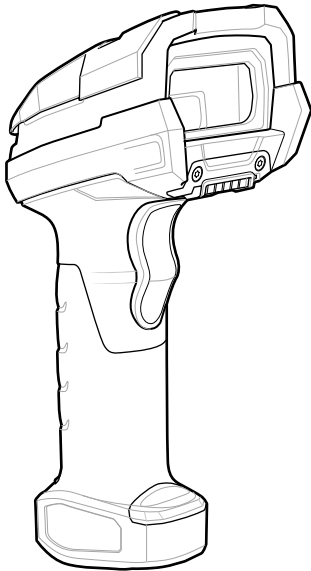

Refer to the LI3678 Product Reference Guide for more information.



**NOTE:** To read a barcode, a scan-enabled app is required. The device contains the DataWedge app that allows you to enable the scanner to decode barcode data and display the barcode content.

To scan with the LI3678:

1. Pair the LI3678 with the device. See [Pairing a Bluetooth Scanner](#) for more information.
2. Ensure that an app is open on the device and a text field is in focus (text cursor in text field).
3. Point the LI3678 at a barcode.
4. Press and hold the trigger.

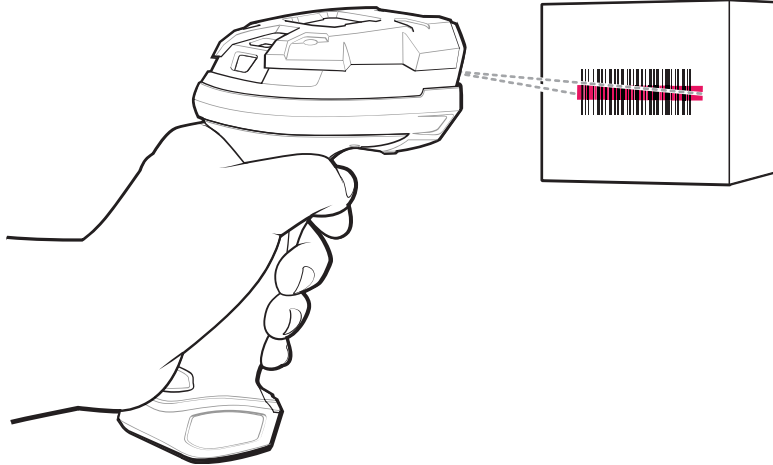

5. Ensure the aiming pattern covers the barcode.

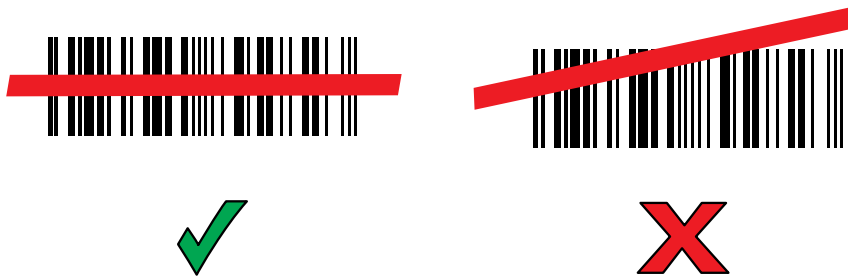

Upon successful decode, the scanner beeps and the LED displays a single green flash.  
The captured data appears in the text field.

## DataWedge

DataWedge is a utility that adds advanced barcode scanning capability to any application without writing code. It runs in the background and handles the interface to built-in barcode scanners. DataWedge converts the captured barcode data to keystrokes and sends it to the target application as if it were typed on the keypad.

DataWedge allows any app on the device to get data from input sources such as a barcode scanner, MSR, RFID, voice, or serial port and manipulate the data based on options or rules.

Configure DataWedge to:

- Provide data capture services from any app.
- Use a particular scanner, reader, or other peripheral devices.
- Properly format and transmit data to a specific app.

To configure DataWedge, go to [techdocs.zebra.com/datawedge/](http://techdocs.zebra.com/datawedge/).

## Enabling DataWedge



This procedure provides information on how to enable DataWedge on the device.

1. Swipe up from the bottom of the Home screen and touch .

2. Touch  > **Settings**.
3. Touch the **DataWedge enabled** checkbox.  
A blue checkmark displays in the checkbox indicating that DataWedge is enabled.

### Disabling DataWedge

This procedure provides information on how to disable DataWedge on the device.

1. Swipe up from the bottom of the Home screen and touch .
2. Touch .
3. Touch **Settings**.
4. Uncheck the **DataWedge enabled** checkbox.

### Pairing a Bluetooth Ring Scanner

Before using a Bluetooth Ring Scanner with the device, connect the device to the Ring Scanner.

To connect the Ring Scanner to the device, use one of the following methods:

- Near Field Communication (NFC) (RS5100 and RS6000 only)
- Simple Serial Interface (SSI)
- Bluetooth Human Interface Device (HID) Mode

### Pairing in SSI Mode Using Near Field Communication

The device provides the ability to pair the RS5100/6100 or RS6000 Ring Scanner in SSI Mode using NFC.



**NOTE:** RS5100 or RS6000 Only.

1. Ensure that NFC is enabled on the device.
2. Align the NFC icon on the Ring Scanner with the NFC icon on the back of the device.

The Status LED blinks blue indicating that the Ring Scanner is attempting to establish a connection with the device. When a connection is established, the Status LED turns off and the Ring Scanner emits a single string of low/high beeps.

A notification appears on the device screen.

The  icon appears in the Status bar.

### Pairing in HID Mode Using Near Field Communication

The device provides the ability to pair the RS5100/RS6100 or RS6000 Ring Scanner in HID Mode using NFC.



**NOTE:** RS5100/RS6100 or RS6000 Only.

1. Ensure that NFC is enabled on the device.

2. Ensure that Bluetooth is enabled on both devices.
3. Ensure that the Bluetooth device to discover is in discoverable mode.
4. Ensure that the two devices are within 10 meters (32.8 feet) of one another.
5. Place the Ring Scanner in Human Interface Device (HID) mode. If the Ring Scanner is already in HID mode, skip to step 6.
  - a) Remove the battery from the Ring Scanner.
  - b) Press and hold the Restore key.
  - c) Install the battery onto the Ring Scanner.
  - d) Keep holding the Restore key for about five seconds until a chirp is heard and the Scan LEDs flash green.
  - e) Scan the barcode below to place the Ring Scanner in HID mode.

**Figure 26** Bluetooth HID Barcode

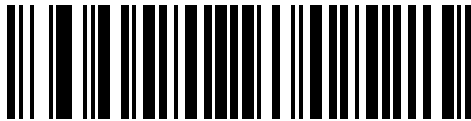

6. Remove the battery from the Ring Scanner.
7. Re-install the battery into the Ring Scanner.
8. Align the NFC icon on the Ring Scanner with the NFC icon on the device.

The Status LED blinks blue indicating that the Ring Scanner is attempting to establish a connection with the device. When a connection is established, the Status LED turns off and the Ring Scanner emits a single string of low/high beeps.

A notification displays on the device screen.

The **A** icon displays in the Status bar.

### Pairing Using Simple Serial Interface (SSI)

Pair the Ring Scanner to the device using Simple Serial Interface.

1. Swipe up from the bottom of the Home screen and touch .

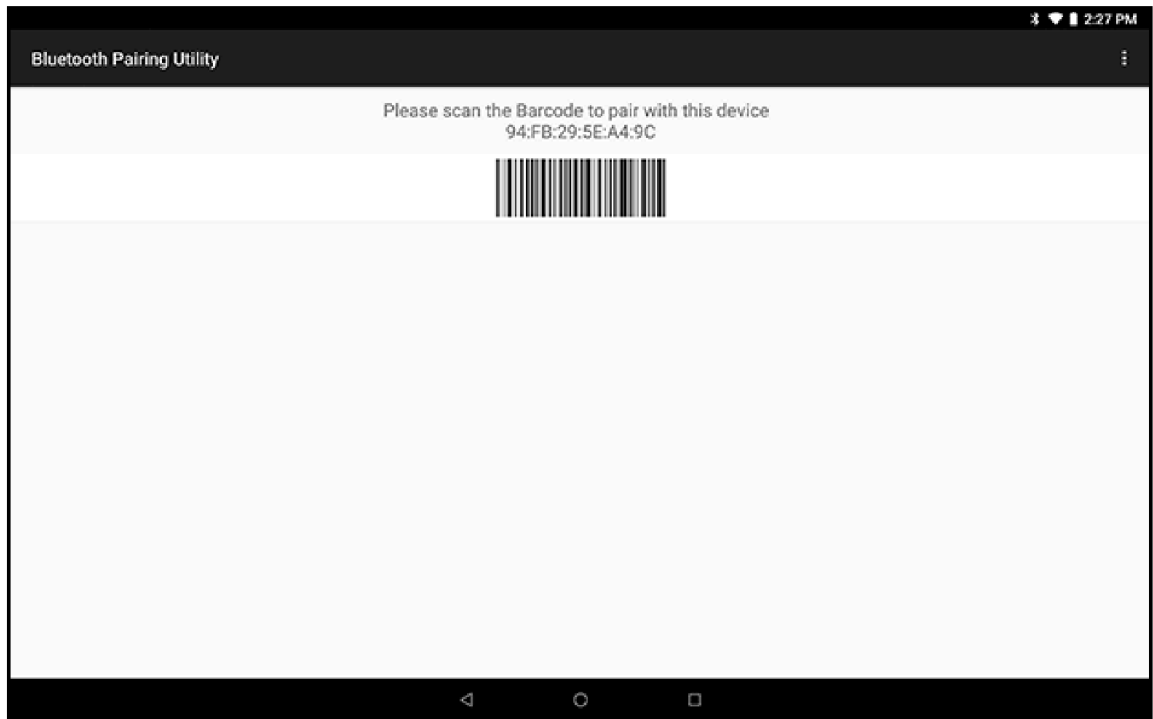

2. Using the Ring Scanner, scan the barcode on the screen.

The Ring Scanner emits a string of high/low/high/low beeps. The Scan LED flashes green indicating that the Ring Scanner is attempting to establish a connection with the device. When a connection is established, the Scan LED turns off and the Ring Scanner emits one string of low/high beeps.

A notification displays on the Notification panel and the  icon displays in the Status bar.

## Pairing the Ring Scanner Using Bluetooth Human Interface Device

Pair the Ring Scanner to the device using Human Interface Device (HID).

1. Ensure that Bluetooth is enabled on both devices.
2. Ensure that the Bluetooth device to discover is in discoverable mode.
3. Ensure that the two devices are within 10 m (32.8 ft) of one another.
4. Place the Ring Scanner in HID mode. If the Ring Scanner is already in HID mode, skip to step 5.
  - a) Remove the battery from the Ring Scanner.
  - b) Press and hold **Restore**.
  - c) Install the battery onto the Ring Scanner.
  - d) Keep holding the Restore key for about five seconds until a chirp is heard and the Scan LEDs flash green.

- e) Scan the barcode below to place the Ring Scanner in HID mode.

Figure 27 RS507 Bluetooth HID Barcode

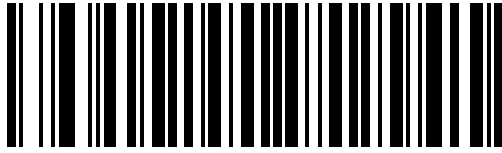
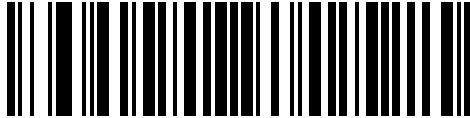



Figure 28 RS6000 Bluetooth HID Barcode



5. Remove the battery from the Ring Scanner.
6. Re-install the battery into the Ring Scanner.
7. Swipe down from the Status bar to open the Quick Access panel and then touch .
8. Touch **Bluetooth**.
9. Touch **Pair new device**. The device begins searching for discoverable Bluetooth devices in the area and displays them under **Available devices**.
10. Scroll through the list and select Ring Scanner.

The device connects to the Ring Scanner and **Connected** displays below the device name. The Bluetooth device is added to the **Paired devices** list and a trusted (“paired”) connection is established.

A notification displays on the Notification panel and the  icon displays in the Status bar.

## Pairing a Bluetooth Scanner

Before using a Bluetooth scanner with the device, connect the device to the Bluetooth scanner.

Connect the scanner to the device using one of the following methods:

- Simple Serial Interface (SSI) mode
- Bluetooth Human Interface Device (HID) mode

### Pairing Using Simple Serial Interface

Pair the Bluetooth scanner to the device using Simple Serial Interface (SSI).

1. Ensure that the two devices are within 10 meters (32.8 feet) of one another.
2. Install the battery into the scanner.

3. Swipe up from the bottom of the Home screen and touch .

**Figure 29** Bluetooth Pairing Utility

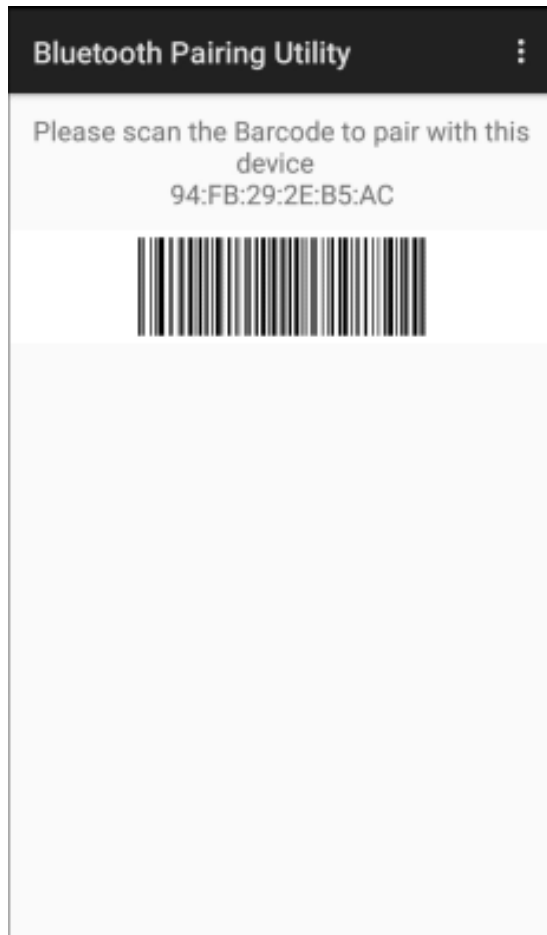

4. Using the Bluetooth scanner, scan the barcode on the screen.

The scanner emits a string of high/low/high/low beeps. The Scan LED flashes green indicating that the Ring Scanner is attempting to establish a connection with the device. When a connection is established, the Scan LED turns off and the Ring Scanner emits one string of low/high beeps.

A notification appears on the Notification panel and the  icon appears in the Status bar.

## Pairing Using Bluetooth Human Interface Device

This section describes how to pair a Bluetooth scanner using Human Interface Device (HID).

To pair the scanner with the device using HID:

1. Remove the battery from the scanner.
2. Replace the battery.
3. After the scanner reboots, scan the barcode below to place the scanner in HID mode.



4. On the device, swipe down from the Status bar to open the Quick Access panel and then touch .
5. Touch **Bluetooth**.
6. Touch **Pair new device**. The device begins searching for discoverable Bluetooth devices in the area and displays them under **Available devices**.
7. Scroll through the list and select XXXXX xxxxxx, where XXXXX is the scanner and xxxxxx is the serial number.

The device connects to the scanner, the scanner beeps once and **Connected** appears below the device name. The Bluetooth device is added to the **Paired devices** list and a trusted (paired) connection is established.

## Supported Decoders

The device supports the decoders listed in the following sections.

### SE4100 Internal Imager Supported Decoders

This section lists the supported decoders for the internal SE4100 imager.

**Table 13** Internal SE4100 Imager Supported Decoders

| Decoder           | Default State | Decoder              | Default State | Decoder           | Default State |
|-------------------|---------------|----------------------|---------------|-------------------|---------------|
| Australian Postal | O             | EAN8                 | X             | MSI               | O             |
| Aztec             | X             | Grid Matrix          | O             | PDF417            | X             |
| Canadian Postal   | —             | GS1 DataBar          | X             | QR Code           | X             |
| Chinese 2 of 5    | O             | GS1 DataBar Expanded | X             | Decoder Signature | —             |
| Codabar           | X             | GS1 DataBar Limited  | X             | TLC 39            | O             |
| Code 11           | O             | GS1 Datamatrix       | O             | Trioptic 39       | O             |
| Code 128          | X             | GS1 QRCode           | —             | UK Postal         | O             |
| Code 39           | X             | HAN XIN              | O             | UPCA              | X             |
| Code 93           | O             | Interleaved 2 of 5   | X             | UPCE0             | X             |
| Composite AB      | O             | Japanese Postal      | O             | UPCE1             | O             |
| Composite C       | O             | Korean 3 of 5        | O             | US4state          | —             |
| Discrete 2 of 5   | O             | MAIL MARK            | O             | US4state FICS     | —             |

**Table 13** Internal SE4100 Imager Supported Decoders (Continued)

| Decoder      | Default State | Decoder       | Default State | Decoder    | Default State |
|--------------|---------------|---------------|---------------|------------|---------------|
| Datamatrix   | X             | Matrix 2 of 5 | O             | US Planet  | O             |
| Dutch Postal | —             | Maxicode      | O             | US Postnet | O             |
| DotCode      | O             | MicroPDF      | O             |            |               |
| EAN13        | X             | MicroQR       | X             |            |               |

Key: X = Enabled, O = Disabled, - = Not Supported

## SR500 Internal Imager Supported Decoders

This section lists the supported decoders for the SR500 internal imager.

**Table 14** SR500 Internal Imager-Supported Decoders

| Decoder           | Default State | Decoder              | Default State | Decoder           | Default State |
|-------------------|---------------|----------------------|---------------|-------------------|---------------|
| Australian Postal | O             | EAN8                 | X             | MSI               | O             |
| Aztec             | X             | Grid Matrix          | O             | PDF417            | X             |
| Canadian Postal   | O             | GS1 DataBar          | X             | QR Code           | X             |
| Chinese 2 of 5    | O             | GS1 DataBar Expanded | X             | Decoder Signature | O             |
| Codabar           | X             | GS1 DataBar Limited  | O             | TLC 39            | O             |
| Code 11           | O             | GS1 Datamatrix       | O             | Trioptic 39       | O             |
| Code 128          | X             | GS1 QRCode           | O             | UK Postal         | O             |
| Code 39           | X             | HAN XIN              | O             | UPCA              | X             |
| Code 93           | O             | Interleaved 2 of 5   | O             | UPCE0             | X             |
| Composite AB      | O             | Japanese Postal      | O             | UPCE1             | O             |
| Composite C       | O             | Korean 3 of 5        | O             | US4state          | O             |
| Discrete 2 of 5   | O             | MAIL MARK            | X             | US4state FICS     | O             |
| Datamatrix        | X             | Matrix 2 of 5        | O             | US Planet         | O             |
| Dutch Postal      | O             | Maxicode             | X             | US Postnet        | O             |
| DotCode           | O             | MicroPDF             | O             |                   |               |
| EAN13             | X             | MicroQR              | O             |                   |               |

Key: X = Enabled, O = Disabled, - = Not Supported

## Camera Supported Decoders

This section lists the supported decoders for the internal camera.

**Table 15** Camera-Supported Decoders

| Decoder           | Default State | Decoder              | Default State | Decoder           | Default State |
|-------------------|---------------|----------------------|---------------|-------------------|---------------|
| Australian Postal | O             | EAN8                 | X             | MSI               | O             |
| Aztec             | X             | Grid Matrix          | O             | PDF417            | X             |
| Canadian Postal   | O             | GS1 DataBar          | X             | QR Code           | X             |
| Chinese 2 of 5    | O             | GS1 DataBar Expanded | X             | Decoder Signature | O             |
| Codabar           | X             | GS1 DataBar Limited  | O             | TLC 39            | O             |
| Code 11           | O             | GS1 Datamatrix       | O             | Trioptic 39       | O             |
| Code 128          | X             | GS1 QRCode           | O             | UK Postal         | O             |
| Code 39           | X             | HAN XIN              | O             | UPCA              | X             |
| Code 93           | O             | Interleaved 2 of 5   | O             | UPCEO             | X             |
| Composite AB      | O             | Japanese Postal      | O             | UPCE1             | O             |
| Composite C       | O             | Korean 3 of 5        | O             | US4state          | O             |
| Discrete 2 of 5   | O             | MAIL MARK            | X             | US4state FICS     | O             |
| Datamatrix        | X             | Matrix 2 of 5        | O             | US Planet         | O             |
| Dutch Postal      | O             | Maxicode             | X             | US Postnet        | O             |
| DotCode           | X             | MicroPDF             | O             |                   |               |
| EAN13             | X             | MicroQR              | O             |                   |               |

Key: X = Enabled, O = Disabled, - = Not Supported

## RS507/RS507x Supported Decoders

This section lists the supported decoders for the RS507/RS507x Ring Scanner.

**Table 16** RS507/RS507x Supported Decoders

| Decoder           | Default State | Decoder     | Default State | Decoder | Default State |
|-------------------|---------------|-------------|---------------|---------|---------------|
| Australian Postal | O             | EAN8        | X             | MSI     | O             |
| Aztec             | X             | Grid Matrix | O             | PDF417  | X             |
| Canadian Postal   | -             | GS1 DataBar | X             | QR Code | X             |

**Table 16** RS507/RS507x Supported Decoders (Continued)

| Decoder         | Default State | Decoder              | Default State | Decoder           | Default State |
|-----------------|---------------|----------------------|---------------|-------------------|---------------|
| Chinese 2 of 5  | O             | GS1 DataBar Expanded | X             | Decoder Signature | O             |
| Codabar         | X             | GS1 DataBar Limited  | O             | TLC 39            | O             |
| Code 11         | O             | GS1 Datamatrix       | -             | Trioptic 39       | O             |
| Code 128        | X             | GS1 QRCode           | -             | UK Postal         | O             |
| Code 39         | O             | HAN XIN              | -             | UPCA              | X             |
| Code 93         | O             | Interleaved 2 of 5   | O             | UPCEO             | X             |
| Composite AB    | O             | Japanese Postal      | O             | UPCE1             | O             |
| Composite C     | O             | Korean 3 of 5        | O             | US4state          | O             |
| Discrete 2 of 5 | O             | MAIL MARK            | -             | US4state FICS     | O             |
| Datamatrix      | X             | Matrix 2 of 5        | O             | US Planet         | O             |
| Dutch Postal    | O             | Maxicode             | X             | US Postnet        | O             |
| DotCode         | O             | MicroPDF             | O             |                   |               |
| EAN13           | X             | MicroQR              | O             |                   |               |

Key: X = Enabled, O = Disabled, - = Not Supported

## RS5100 Supported Decoders

This section lists the supported decoders for the RS5100 Ring Scanner.

**Table 17** RS5100-Supported Decoders

| Decoder           | Default State | Decoder              | Default State | Decoder           | Default State |
|-------------------|---------------|----------------------|---------------|-------------------|---------------|
| Australian Postal | O             | EAN8                 | X             | MSI               | O             |
| Aztec             | X             | Grid Matrix          | O             | PDF417            | X             |
| Canadian Postal   | O             | GS1 DataBar          | X             | QR Code           | X             |
| Chinese 2 of 5    | O             | GS1 DataBar Expanded | X             | Decoder Signature | O             |
| Codabar           | X             | GS1 DataBar Limited  | O             | TLC 39            | O             |
| Code 11           | O             | GS1 Datamatrix       | O             | Trioptic 39       | O             |
| Code 128          | X             | GS1 QRCode           | O             | UK Postal         | O             |
| Code 39           | X             | HAN XIN              | O             | UPCA              | X             |

**Table 17** RS5100-Supported Decoders (Continued)

| Decoder         | Default State | Decoder            | Default State | Decoder       | Default State |
|-----------------|---------------|--------------------|---------------|---------------|---------------|
| Code 93         | O             | Interleaved 2 of 5 | O             | UPCEO         | X             |
| Composite AB    | O             | Japanese Postal    | O             | UPCE1         | O             |
| Composite C     | O             | Korean 3 of 5      | O             | US4state      | O             |
| Discrete 2 of 5 | O             | MAIL MARK          | X             | US4state FICS | O             |
| Datamatrix      | X             | Matrix 2 of 5      | O             | US Planet     | O             |
| Dutch Postal    | O             | Maxicode           | X             | US Postnet    | O             |
| DotCode         | O             | MicroPDF           | O             |               |               |
| EAN13           | X             | MicroQR            | O             |               |               |

Key: X = Enabled, O = Disabled, - = Not Supported

## RS6000 Supported Decoders

This section lists the supported decoders for the RS6000 Ring Scanner.

**Table 18** RS6000-Supported Decoders

| Decoder           | Default State | Decoder              | Default State | Decoder           | Default State |
|-------------------|---------------|----------------------|---------------|-------------------|---------------|
| Australian Postal | O             | EAN8                 | X             | MSI               | O             |
| Aztec             | X             | Grid Matrix          | O             | PDF417            | X             |
| Canadian Postal   | O             | GS1 DataBar          | X             | QR Code           | X             |
| Chinese 2 of 5    | O             | GS1 DataBar Expanded | X             | Decoder Signature | O             |
| Codabar           | X             | GS1 DataBar Limited  | O             | TLC 39            | O             |
| Code 11           | O             | GS1 Datamatrix       | O             | Trioptic 39       | O             |
| Code 128          | X             | GS1 QRCode           | O             | UK Postal         | O             |
| Code 39           | X             | HAN XIN              | O             | UPCA              | X             |
| Code 93           | O             | Interleaved 2 of 5   | O             | UPCEO             | X             |
| Composite AB      | O             | Japanese Postal      | O             | UPCE1             | O             |
| Composite C       | O             | Korean 3 of 5        | O             | US4state          | O             |
| Discrete 2 of 5   | O             | MAIL MARK            | X             | US4state FICS     | O             |
| Datamatrix        | X             | Matrix 2 of 5        | O             | US Planet         | O             |

**Table 18** RS6000-Supported Decoders (Continued)

| Decoder      | Default State | Decoder  | Default State | Decoder    | Default State |
|--------------|---------------|----------|---------------|------------|---------------|
| Dutch Postal | O             | Maxicode | X             | US Postnet | O             |
| DotCode      | O             | MicroPDF | O             |            |               |
| EAN13        | X             | MicroQR  | O             |            |               |

Key: X = Enabled, O = Disabled, - = Not Supported

## RS6100 Supported Decoders

Lists the supported decoders for the RS6100 Ring Scanner.

**Table 19** RS6100 Supported Decoders

| Decoder           | Default State | Decoder              | Default State | Decoder           | Default State |
|-------------------|---------------|----------------------|---------------|-------------------|---------------|
| Australian Postal | O             | EAN8                 | X             | MSI               | O             |
| Aztec             | X             | Grid Matrix          | O             | PDF417            | X             |
| Canadian Postal   | O             | GS1 DataBar          | X             | QR Code           | X             |
| Chinese 2 of 5    | O             | GS1 DataBar Expanded | X             | Decoder Signature | O             |
| Codabar           | X             | GS1 DataBar Limited  | O             | TLC 39            | O             |
| Code 11           | O             | GS1 Datamatrix       | O             | Trioptic 39       | O             |
| Code 128          | X             | GS1 QRCode           | O             | UK Postal         | O             |
| Code 39           | X             | HAN XIN              | O             | UPCA              | X             |
| Code 93           | O             | Interleaved 2 of 5   | O             | UPCE0             | X             |
| Composite AB      | O             | Japanese Postal      | O             | UPCE1             | O             |
| Composite C       | O             | Korean 3 of 5        | O             | US4state          | O             |
| Discrete 2 of 5   | O             | MAIL MARK            | X             | US4state FICS     | O             |
| Datamatrix        | X             | Matrix 2 of 5        | O             | US Planet         | O             |
| Dutch Postal      | O             | Maxicode             | X             | US Postnet        | O             |
| DotCode           | O             | MicroPDF             | O             |                   |               |
| EAN13             | X             | MicroQR              | O             |                   |               |

Key: X = Enabled, O = Disabled, - = Not Supported

## DS2278 Supported Decoders

This section lists the supported decoders for the DS2278 Digital Scanner.

**Table 20** DS2278 Digital Scanner-Supported Decoders

| Decoder           | Default State | Decoder              | Default State | Decoder           | Default State |
|-------------------|---------------|----------------------|---------------|-------------------|---------------|
| Australian Postal | O             | EAN8                 | X             | MSI               | O             |
| Aztec             | X             | Grid Matrix          | O             | PDF417            | X             |
| Canadian Postal   | —             | GS1 DataBar          | X             | QR Code           | X             |
| Chinese 2 of 5    | O             | GS1 DataBar Expanded | X             | Decoder Signature | O             |
| Codabar           | X             | GS1 DataBar Limited  | O             | TLC 39            | O             |
| Code 11           | O             | GS1 Datamatrix       | O             | Trioptic 39       | O             |
| Code 128          | X             | GS1 QRCode           | O             | UK Postal         | O             |
| Code 39           | X             | HAN XIN              | —             | UPCA              | X             |
| Code 93           | O             | Interleaved 2 of 5   | O             | UPCEO             | X             |
| Composite AB      | O             | Japanese Postal      | O             | UPCE1             | O             |
| Composite C       | O             | Korean 3 of 5        | O             | US4state          | O             |
| Discrete 2 of 5   | O             | MAIL MARK            | X             | US4state FICS     | O             |
| Datamatrix        | X             | Matrix 2 of 5        | O             | US Planet         | O             |
| Dutch Postal      | O             | Maxicode             | X             | US Postnet        | O             |
| DotCode           | O             | MicroPDF             | O             |                   |               |
| EAN13             | X             | MicroQR              | O             |                   |               |

Key: X = Enabled, O = Disabled, — = Not Supported

## DS3678 Supported Decoders

This section lists the supported decoders for the DS3678 scanner.

**Table 21** DS3678-Supported Decoders

| Decoder           | Default State | Decoder     | Default State | Decoder | Default State |
|-------------------|---------------|-------------|---------------|---------|---------------|
| Australian Postal | O             | EAN8        | X             | MSI     | O             |
| Aztec             | X             | Grid Matrix | O             | PDF417  | X             |
| Canadian Postal   | —             | GS1 DataBar | X             | QR Code | X             |

**Table 21** DS3678-Supported Decoders (Continued)

| Decoder         | Default State | Decoder              | Default State | Decoder           | Default State |
|-----------------|---------------|----------------------|---------------|-------------------|---------------|
| Chinese 2 of 5  | O             | GS1 DataBar Expanded | X             | Decoder Signature | —             |
| Codabar         | X             | GS1 DataBar Limited  | O             | TLC 39            | O             |
| Code 11         | O             | GS1 Datamatrix       | O             | Trioptic 39       | O             |
| Code 128        | X             | GS1 QRCode           | O             | UK Postal         | O             |
| Code 39         | X             | HAN XIN              | O             | UPCA              | X             |
| Code 93         | O             | Interleaved 2 of 5   | O             | UPCEO             | X             |
| Composite AB    | O             | Japanese Postal      | O             | UPCE1             | O             |
| Composite C     | O             | Korean 3 of 5        | O             | US4state          | O             |
| Discrete 2 of 5 | O             | MAIL MARK            | X             | US4state FICS     | O             |
| Datamatrix      | X             | Matrix 2 of 5        | O             | US Planet         | O             |
| Dutch Postal    | O             | Maxicode             | X             | US Postnet        | O             |
| DotCode         | O             | MicroPDF             | O             |                   |               |
| EAN13           | X             | MicroQR              | O             |                   |               |

Key: X = Enabled, O = Disabled, — = Not Supported

## DS8178 Supported Decoders

This section lists the supported decoders for the DS8178 Digital scanner.

**Table 22** DS8178 Digital Scanner-Supported Decoders

| Decoder           | Default State | Decoder              | Default State | Decoder           | Default State |
|-------------------|---------------|----------------------|---------------|-------------------|---------------|
| Australian Postal | O             | EAN8                 | X             | MSI               | O             |
| Aztec             | X             | Grid Matrix          | O             | PDF417            | X             |
| Canadian Postal   | —             | GS1 DataBar          | X             | QR Code           | X             |
| Chinese 2 of 5    | O             | GS1 DataBar Expanded | X             | Decoder Signature | —             |
| Codabar           | X             | GS1 DataBar Limited  | O             | TLC 39            | O             |
| Code 11           | O             | GS1 Datamatrix       | O             | Trioptic 39       | O             |
| Code 128          | X             | GS1 QRCode           | O             | UK Postal         | O             |
| Code 39           | X             | HAN XIN              | —             | UPCA              | X             |

**Table 22** DS8178 Digital Scanner-Supported Decoders (Continued)

| Decoder         | Default State | Decoder            | Default State | Decoder       | Default State |
|-----------------|---------------|--------------------|---------------|---------------|---------------|
| Code 93         | O             | Interleaved 2 of 5 | O             | UPCEO         | X             |
| Composite AB    | O             | Japanese Postal    | O             | UPCE1         | O             |
| Composite C     | O             | Korean 3 of 5      | O             | US4state      | O             |
| Discrete 2 of 5 | O             | MAIL MARK          | X             | US4state FICS | O             |
| Datamatrix      | X             | Matrix 2 of 5      | O             | US Planet     | O             |
| Dutch Postal    | O             | Maxicode           | X             | US Postnet    | O             |
| DotCode         | O             | MicroPDF           | O             |               |               |
| EAN13           | X             | MicroQR            | O             |               |               |

Key: X = Enabled, O = Disabled, — = Not Supported

## LI3678 Supported Decoders

This section lists the supported decoders for the LI3678 scanner.

**Table 23** LI3678-Supported Decoders

| Decoder           | Default State | Decoder              | Default State | Decoder           | Default State |
|-------------------|---------------|----------------------|---------------|-------------------|---------------|
| Australian Postal | —             | EAN8                 | X             | MSI               | O             |
| Aztec             | —             | Grid Matrix          | O             | PDF417            | —             |
| Canadian Postal   | —             | GS1 DataBar          | X             | QR Code           | —             |
| Chinese 2 of 5    | O             | GS1 DataBar Expanded | X             | Decoder Signature | —             |
| Codabar           | X             | GS1 DataBar Limited  | O             | TLC 39            | O             |
| Code 11           | O             | GS1 Datamatrix       | —             | Trioptic 39       | O             |
| Code 128          | X             | GS1 QRCode           | —             | UK Postal         | —             |
| Code 39           | X             | HAN XIN              | O             | UPCA              | X             |
| Code 93           | O             | Interleaved 2 of 5   | O             | UPCEO             | X             |
| Composite AB      | —             | Japanese Postal      | —             | UPCE1             | O             |
| Composite C       | —             | Korean 3 of 5        | O             | US4state          | —             |
| Discrete 2 of 5   | O             | MAIL MARK            | —             | US4state FICS     | —             |
| Datamatrix        | —             | Matrix 2 of 5        | O             | US Planet         | —             |

**Table 23** LI3678-Supported Decoders (Continued)

| Decoder      | Default State | Decoder  | Default State | Decoder    | Default State |
|--------------|---------------|----------|---------------|------------|---------------|
| Dutch Postal | —             | Maxicode | —             | US Postnet | —             |
| DotCode      | O             | MicroPDF | —             |            |               |
| EAN13        | X             | MicroQR  | —             |            |               |

Key: X = Enabled, O = Disabled, — = Not Supported

# Wireless

This section provides information on the wireless features of the device.

## Wireless Wide Area Networks

Use Wireless wide area networks (WWANs) to access data over a cellular network on the device.

This section provides information on:

- Sharing a data connection
- Monitoring data usage
- Changing Cellular Network settings

## Sharing the Mobile Data Connection

The **Hotspot & tethering** settings allow sharing the mobile data connection with a single computer via USB tethering or Bluetooth tethering.

Share the data connection with up to eight devices at once, by turning it into a portable Wi-Fi hotspot. While the device is sharing its data connection, an icon displays at the top of the screen and a corresponding message displays in the notification list.

### Enabling USB Tethering

This section describes how to enable USB Tethering.



**NOTE:** USB tethering is not supported on computers running macOS. If the computer is running Windows or a recent version of Linux (such as Ubuntu), follow these instructions without any special preparation. If running a version of Windows that precedes Windows 11, or some other operating system, you may need to prepare the computer to establish a network connection via USB.

1. Connect the device to a host computer with a USB cable.  
The notification **Charging this device via USB** displays in the Notifications panel.
2. Go to **Settings**.
3. Touch **Network & Internet**.
4. Touch **Hotspot & tethering**.
5. Touch the **USB tethering** switch to enable.

The host computer is now sharing the device's data connection.

To stop sharing the data connection, touch the **USB tethering** switch again or disconnect the USB cable.

### Enabling Bluetooth Tethering

Use Bluetooth tethering to share the data connection with a host computer.

Configure the host computer to obtain its network connection using Bluetooth. For more information, refer to the host computer's documentation.

1. Go to **Settings**.
2. Touch **Network & Internet > Hotspot & tethering**.
3. Touch the **Bluetooth tethering** switch to enable.

The host computer is now sharing the device's data connection.

To stop sharing the data connection, touch the **Bluetooth tethering** switch again.

### Enabling Wi-Fi Hotspot

This section describes the method for enabling a Wi-Fi hotspot.

1. Go to **Settings**.
2. Touch **Network & Internet**.
3. Touch **Hotspot & tethering**.
4. Touch **Wi-Fi hotspot**.
5. Toggle the switch to enable.

After a moment, the device starts broadcasting its Wi-Fi network name (SSID). Connect to it with up to eight computers or other devices. The Hotspot  icon appears in the Status bar.

To stop sharing the data connection, touch the toggle switch again.

### Configuring the Wi-Fi Hotspot

Use Wi-Fi Hotspot to share the device's data connection with another computer.

1. Go to **Settings**.
2. Touch **Network & internet**.
3. Touch **Hotspot & tethering**.
4. Touch **Wi-Fi hotspot**.
5. Enable the **Use Wi-Fi hotspot** toggle switch to turn on Wi-Fi hotspot.
6. Touch **Hotspot** name, edit the name of the hotspot, and touch **OK**.
7. Touch **Security** and select a security method from the drop-down list.
  - **WPA3-Personal**
    - a. Touch **Hotspot password**.
    - b. Enter a password.
    - c. Touch **OK**.

- **WPA2/WPA3-Personal**
    - a. Touch **Hotspot password**.
    - b. Enter a password.
    - c. Touch **OK**.
  - **WPA2-Personal**
    - a. Touch **Hotspot password**.
    - b. Enter a password.
    - c. Touch **OK**.
  - **None** - If **None** is selected in the Security option, a password is not required.
8. Touch **Hotspot password** to set a password.
  9. Enable the **Turn off hotspot automatically** toggle switch to turn off Wi-Fi hotspot automatically when no devices are connected.
  10. Touch **Speed & compatibility**, and select a frequency **2.4 GHz Band**, **5.0 GHz Band**, or **6.0 GHz Band** for your hotspot.
  11. Touch **Additional Settings** to configure Band selected, Channel selection, Maximum number of clients, and Hotspot connected clients.

## Data Usage

Data usage refers to the amount of data uploaded or downloaded by the device during a given period. Depending on the wireless plan, you may be charged additional fees when your data usage exceeds your plan's limit.

Data usage settings allow you to:

- Enable Data Saver.
- Set the data usage warning level.
- Set a data usage limit.
- View or restrict data usage by app.
- Identify mobile hotspots and restrict background downloads that may result in extra charges.

### Setting Data Usage Warning

Set a warning alert when the device has used a certain amount of mobile data.

1. Go to **Settings**.
2. Touch **Network & internet > SIMs > Data warning & limit**.
3. If necessary, touch **Set data warning** to enable it.
4. Touch **Data warning**.
5. Enter a number.  
To switch between megabytes (MB) and gigabytes (GB), touch the down arrow.
6. Touch **SET**.

When the data usage reaches the set level, a notification appears.

### Setting Data Limit

To help manage your mobile data, set up a Daily limit. The device notifies you when you have reached this limit, so you can decide to keep using data or block data usage until the end of the day.



**NOTE:** Only for WWAN devices.

1. Go to **Settings**.
2. Touch **Network & internet > SIMs > Data warning & limit**.
3. Touch **Set data limit**.
4. Touch **OK**.
5. Touch **Data limit**.
6. Enter a number.

To switch between megabytes (MB) and gigabytes (GB), touch the down arrow.

7. Touch **Set**.

When the limit is reached, data automatically turns off and a notification displays.

### Cellular Network Settings

Cellular network settings applies to WWAN devices only.

#### Data When Roaming

Roaming is disabled by default to prevent the device from transmitting data over other carriers' mobile networks when leaving an area that is covered by the carrier's networks. This is useful for controlling expenses if the service plan does not include data roaming.

#### Enabling MMS Messages

When mobile data is disabled, this feature allows you to send and receive MMS messages using Wi-Fi. This option only displays when mobile data is disabled.

1. Go to **Settings**.
2. Touch **Network & Internet > Mobile network > Mobile data**.
3. Touch **MMS messages**.
4. If desired, touch **Mobile data** to turn mobile data back on.

You can now send and receive MMS messages using Wi-Fi whenever mobile data is disabled.

#### Setting Preferred Network Type

Change the device network operating mode.

1. Go to **Settings**.
2. Touch **Network & Internet > Mobile network > Preferred network type**.

3. In the **Preferred network type** dialog box, select a mode to set as default.
  - Automatic(NLW)
  - NR 5G only
  - LTE only
  - 3G only

### Setting Preferred Network

Change the device network operating mode.

1. Go to **Settings**.
2. Touch **Network & internet > SIMs > Automatically select network**.
3. Touch **Automatically select network**.
4. Touch **Network**.
5. In the **Available network** list, select a carrier network.

### Configuring the Access Point Name

To use the data on a network, configure the APN information on the ET46.



**NOTE:** Many service provider Access Point Name (APN) data are pre-configured in the device. The APN information for all other service providers must be obtained from the wireless service provider.

1. Go to **Settings**.
2. On Android 15, touch **Network & Internet > Mobile network**.
3. Select the SIM card.
4. Touch **Access Point Names**.
5. Touch an APN name in the list to edit an existing APN or touch **+** to create a new APN.
6. Touch each APN setting and enter the appropriate data obtained from the wireless service provider.
7. When finished, touch **⋮ > Save**.
8. Touch the radio button next to the APN name to start using it.

### Locking the SIM Card

Locking the SIM card requires you to enter a PIN every time the device is turned on. If the correct PIN is not entered, only emergency calls can be made.

1. Go to **Settings**.
2. Touch **Security > More Security Settings > SIM Lock**.
3. Touch **Lock SIM card**.
4. Enter the PIN associated with the card.
5. Touch **OK**.
6. Reset the device.

## Supported Frequency Bands

The frequency bands supported by the device vary depending on the configuration available for your region.

**Table 24** North America (United States and Canada)

| 5G NR FR1 Bands | LTE FDD/TDD Bands |
|-----------------|-------------------|
| n1              | B1                |
| n2              | B2                |
| n3              | B3                |
| n5              | B4                |
| n7              | B5                |
| n8              | B7                |
| n12             | B8                |
| n13             | B12               |
| n14             | B13               |
| n20             | B14               |
| n25             | B17               |
| n26             | B18               |
| n28             | B19               |
| n29             | B20               |
| n30             | B25               |
| n38             | B26               |
| n40             | B28               |
| n41             | B29               |
| n48             | B30               |
| n53             | B32               |
| n66             | B34               |
| n70             | B38               |
| n71             | B39               |
| n75             | B40               |
| n76             | B41               |
| n77             | B42               |
| n78             | B43               |
| n79             | B48               |
| –               | B53               |
| –               | B66               |

**Table 24** North America (United States and Canada) (Continued)

| 5G NR FR1 Bands | LTE FDD/TDD Bands |
|-----------------|-------------------|
| –               | B68               |
| –               | B70               |
| –               | B71               |
| –               | B106              |

**Table 25** Rest of World and China

| 5G NR FR1 Bands | LTE FDD/TDD Bands | 2G   |
|-----------------|-------------------|------|
| n1              | B1                | 850  |
| n2              | B2                | 900  |
| n3              | B3                | 1800 |
| n5              | B4                | 1900 |
| n7              | B5                | –    |
| n8              | B7                | –    |
| n12             | B8                | –    |
| n13             | B12               | –    |
| n14             | B13               | –    |
| n20             | B14               | –    |
| n25             | B17               | –    |
| n26             | B18               | –    |
| n28             | B19               | –    |
| n29             | B20               | –    |
| n30             | B25               | –    |
| n38             | B26               | –    |
| n40             | B28               | –    |
| n41             | B29               | –    |
| n48             | B30               | –    |
| n53             | B32               | –    |
| n66             | B34               | –    |
| n70             | B38               | –    |
| n71             | B39               | –    |
| n75             | B40               | –    |
| n76             | B41               | –    |
| n77             | B42               | –    |

**Table 25** Rest of World and China (Continued)

| 5G NR FR1 Bands | LTE FDD/TDD Bands | 2G |
|-----------------|-------------------|----|
| n78             | B43               | —  |
| n79             | B48               | —  |
| —               | B53               | —  |
| —               | B66               | —  |
| —               | B68               | —  |
| —               | B70               | —  |
| —               | B71               | —  |
| —               | B106              | —  |

## Wireless Local Area Networks

Wireless local area networks (WLANs) allow the device to communicate wirelessly inside a building. Before using the device on a WLAN, the facility must be set up with the required hardware to run the WLAN (sometimes known as infrastructure). The infrastructure and the device must both be properly configured to enable this communication.



**NOTE:** To extend the life of the battery, turn off Wi-Fi when not in use.

Refer to the documentation provided with the infrastructure (access points (APs), access ports, switches, Radius servers, etc.) for instructions on how to set up the infrastructure.

Once the infrastructure is set up to enforce the chosen WLAN security scheme, use the **Network & Internet** settings to configure the device to match the security scheme.

The device supports the following WLAN security options:

- None
- Enhanced Open
- Open
- Wireless Equivalent Privacy (WEP)
- Wi-Fi Protected Access (WPA)/WPA2 Personal (PSK)
- WPA3-Personal
- WPA/WPA2 - Enterprise
  - Protected Extensible Authentication Protocol (PEAP)
  - Transport Layer Security (TLS)
  - Tunneled Transport Layer Security (TTLS) - with Password Authentication Protocol (PAP), MSCHAP, MSCHAPv2, and GTC authentication
  - Password (PWD)
  - Extensible Authentication Protocol Method for Subscriber Identity Module (SIM)
  - Extensible Authentication Protocol Method for Authentication and Key Agreement (AKA)

- Improved Extensible Authentication Protocol Method for Authentication and Key Agreement (AKA)
- WPA3-Enterprise 192-bit
  - The **Status** bar displays icons that indicate Wi-Fi network availability and Wi-Fi status
- WPA3 - Enterprise
  - Protected Extensible Authentication Protocol (PEAP)
  - Transport Layer Security (TLS)
  - Tunneled Transport Layer Security (TTLS) - with Password Authentication Protocol (PAP), MSCHAP, MSCHAPv2, and GTC authentication
  - Password (PWD)
  - Extensible Authentication Protocol Method for Subscriber Identity Module (SIM)
  - Extensible Authentication Protocol Method for Authentication and Key Agreement (AKA)
  - Improved Extensible Authentication Protocol Method for Authentication and Key Agreement (AKA)

### Connecting to a Wi-Fi Network

Most of the device's functionality requires an internet connection. Connect to an available Wi-Fi network to use the device features.

1. Go to **Settings**.
2. Touch **Network & internet**.
3. Touch **Internet** to open the Internet screen.
4. Enable the **Wi-Fi** toggle switch.

The device searches for WLANs in the area and lists them.
5. Scroll through the list and select the desired WLAN network.
6. For open networks, touch the profile once or press and hold and then select **Connect** or for secure networks, enter the required password or other credentials, then touch **Connect**. See the system administrator for more information.

The device obtains a network address and other required information from the network using the dynamic host configuration protocol (DHCP). To configure the device with a fixed internet protocol (IP) address, go to [Configuring the Device to Use a Static IP Address](#).

7. In the Wi-Fi setting field, **Connected** displays, indicating that the device is connected to the WLAN.

### Removing a Wi-Fi Network

Remove a remembered or connected Wi-Fi network.

1. Go to **Settings**.
2. Touch **Network & Internet**.
3. Touch **Internet**.
4. Disable the **Wi-Fi** toggle switch.

5. Touch **Saved networks**.
6. Touch the name of the network.
7. Touch **Forget**.

## WLAN Configuration

This section provides information on configuring Wi-Fi settings.

### Configuring a Secure Wi-Fi Network

Add a Wi-Fi network on the device to connect to the internet.

1. Go to **Settings**.
2. Touch **Network & Internet**.
3. Touch **Internet**.
4. Slide the Wi-Fi switch to the **ON** position.  
The device searches for WLANs in the area and lists them on the screen.
5. Scroll through the list and select the desired WLAN network.
6. Touch the desired network. If network security is **Open**, the device automatically connects to the network. For all other network security, a dialog box displays.
7. If network security is **WPA/WPA2-Personal**, or **WEP**, enter the required password and then touch **Connect**.
8. If network security is **WPA/WPA2-Enterprise** or **WPA3-Enterprise**:
  - a) Touch the **EAP method** drop-down list and select one of the following:
    - **PEAP**
    - **TLS**
    - **TTLS**
    - **PWD**
    - **SIM**
    - **AKA**
    - **AKA'**
  - b) Fill in the appropriate information. Options vary depending on the **EAP method** chosen.
    - When selecting **CA certificate**, Certification Authority (CA) certificates are installed using the **Security** settings.
    - When using the EAP methods PEAP, TLS, or TTLS, specify a domain.
    - Touch **Advanced options** to display additional network options.
9. If the network security is **WPA3-Enterprise 192-bit**:
  - Touch **CA certificate** and select a Certification Authority (CA) certificate.



**NOTE:** Certificates are installed using the Security settings.

- For WPA3-Enterprise 192-bit, specify a domain.
- Touch **User certificate** and select a user certificate.



**NOTE:** User certificates are installed using the Security settings.

- In the **Identity** text box, enter the username credentials.



**NOTE:** By default, the network Proxy is set to None and the IP settings is set to DHCP. Go to [Configuring for a Proxy Server](#) for setting the connection to a proxy server and go to [Configuring the Device to Use a Static IP Address](#) for setting the device to use a static IP address.

10. Touch **Connect**.

### Manually Adding a Wi-Fi Network

Manually add a Wi-Fi network if the network does not broadcast its name (SSID) or to add a Wi-Fi network when out of range.

1. Go to **Settings**.
2. Touch **Network & Internet**.
3. Touch **Internet**.
4. Slide the Wi-Fi switch to the **On** position.
5. Scroll to the bottom of the list and select **Add network**.
6. In the **Network name** text box, enter the name of the Wi-Fi network.
7. In the **Security** drop-down list, set the type of security to:
  - None
  - Enhanced Open
  - WEP
  - WPA/WPA2-Personal
  - WPA3-Personal
  - WPA/WPA2-Enterprise/WPA3-Enterprise
  - WPA3-Enterprise 192-bit
8. If the network security is **None** or **Enhanced Open**, touch **Save**.
9. If the network security is **WEP**, **WPA3-Personal**, or **WPA/WPA2-Personal**, enter the required password and then touch **Save**.



**NOTE:** By default, the network Proxy is set to None and the IP settings is set to DHCP. Go to [Configuring for a Proxy Server](#) for setting the connection to a proxy server and go to [Configuring the Device to Use a Static IP Address](#) for setting the device to use a static IP address.

10. If network security is **WPA/WPA2-Enterprise/WPA3-Enterprise**:
  - a) Touch the **EAP method** drop-down list and select one of the following:
    - **PEAP**
    - **TLS**

- TTLS
- PWD
- SIM
- AKA
- AKA'

b) Fill in the appropriate information. Options vary depending on the **EAP method** chosen.

- When selecting **CA certificate**, Certification Authority (CA) certificates are installed using the **Security** settings.
- When using the EAP methods PEAP, TLS, or TTLS, specify a domain.
- Touch **Advanced options** to display additional network options.

11. If the network security is **WPA3-Enterprise 192-bit**:

- Touch **CA certificate** and select a Certification Authority (CA) certificate.



**NOTE:** Certificates are installed using the Security settings.

- For WPA3-Enterprise 192-bit, specify a domain.
- Touch **User certificate** and select a user certificate.



**NOTE:** User certificates are installed using the Security settings.

- In the **Identity** text box, enter the username credentials.

12. Touch **Save**. To connect to the saved network, touch and hold on the saved network and select **Connect to network**.

## Configuring for a Proxy Server

A proxy server is a server that acts as an intermediary for requests from clients seeking resources from other servers. A client connects to the proxy server and requests some service, such as a file, connection, web page, or other resource, available from a different server. The proxy server evaluates the request according to its filtering rules. For example, it may filter traffic by IP address or protocol. If the request is validated by the filter, the proxy provides the resource by connecting to the relevant server and requesting the service on behalf of the client.

It is important for enterprise customers to be able to set up secure computing environments within their companies, making proxy configuration essential. Proxy configuration acts as a security barrier ensuring that the proxy server monitors all traffic between the Internet and the intranet. This is normally an integral part of security enforcement in corporate firewalls within intranets.

1. Go to **Settings**.
2. Touch **Network & Internet**.
3. Touch **Internet**.
4. Slide the Wi-Fi switch to the **On** position.
5. In the network dialog box, select and touch a network.
6. If configuring the connected network, touch  to edit the network details and then touch the down arrow to hide the keyboard.

7. Touch **Advanced options**.
8. Touch **Proxy** and select **Manual**.
9. In the **Proxy hostname** text box, enter the address of the proxy server.
10. In the **Proxy port** text box, enter the port number for the proxy server.
11. In the **Bypass proxy for** text box, enter addresses for web sites that are not required to go through the proxy server. Use a comma “,” between addresses. Do not use spaces or carriage returns between addresses.
12. If configuring the connected network, touch **Save** otherwise, touch **Connect**.
13. Touch **Connect**.

### Configuring the Device to Use a Static IP Address

By default, the device is configured to use Dynamic Host Configuration Protocol (DHCP) to assign an Internet protocol (IP) address when connecting to a wireless network.

1. Go to **Settings**.
2. Touch **Network & Internet**.
3. Touch **Internet**.
4. Slide the Wi-Fi switch to the **On** position.
5. In the network dialog box, select and touch a network.
6. If configuring the connected network, touch  to edit the network details and then touch the down arrow to hide the keyboard.
7. Touch **Advanced options**.
8. Touch **IP settings** and select **Static**.
9. In the **IP address** text box, enter an IP address for the device.
10. If required, in the **Gateway** text box, enter a gateway address for the device.
11. If required, in the **Network prefix length** text box, enter the prefix length.
12. If required, in the **DNS 1** text box, enter a Domain Name System (DNS) address.
13. If required, in the **DNS 2** text box, enter a DNS address.
14. If configuring the connected network, touch **Save** otherwise, touch **Connect**.

### Wi-Fi Preferences

Use the Wi-Fi preferences to configure advanced Wi-Fi settings. From the Wi-Fi screen, scroll down and touch **Network preferences**.

- **Turn on Wi-Fi automatically** - When enabled, Wi-Fi automatically turns back on when near high-quality saved networks.
- **Notify for public networks** - When enabled, notifies when an open network is available.
- **Allow WEP networks** - When enabled, connects to WEP-secured networks.
- **Additional settings** - Touch to view additional Wi-Fi settings.
- **Install Certificates** - Touch to install certificates.

- **Wi-Fi Direct** - Displays a list of devices available for a direct Wi-Fi connection.

### Additional Wi-Fi Settings

Use the Additional Settings to configure additional Wi-Fi settings.



**NOTE:** Additional Wi-Fi settings are for the device, not for a specific wireless network.

- **Regulatory**
  - **Country Selection** - Displays the acquired country code if 802.11d is enabled, else it displays the currently selected country code.
  - **Region code** - Displays the current region code.
- **Band and Channel Selection**
  - **Wi-Fi frequency band** - Set the frequency band to:
    - **Auto** (default)
    - **5 GHz only**
    - **2.4 GHz only**
    - **6 GHz only**
    - **2.4 GHz and 5 GHz**
    - **2.4 GHz and 6 GHz**
    - **5 GHz and 6 GHz**
  - **Available channels (2.4 GHz)** - Touch to display the **Available channels** menu. Select specific channels and touch **OK**.
  - **Available channels (5 GHz)** - Touch to display the **Available channels** menu. Select specific channels and touch **OK**.
  - **Available channels (6 GHz)** - Touch to display the **Available channels** menu. Select specific channels and touch **OK**.
- **Logging**
  - **Advanced Logging** - Touch to enable logging, enable Wi-Fi Verbose Logging, or change the log directory.
  - **Wireless logs** - Use to capture Wi-Fi log files.
    - **Fusion Logger** - Touch to open the **Fusion Logger** application. This application maintains a history of high level WLAN events which helps to understand the status of connectivity.
    - **Fusion Status** - Touch to display live status of WLAN state. Also provides information about the device and connected profile.
- **About**
  - **Version** - Displays the current version information. Touch the version to display addition version details.

## Enabling Wi-Fi Direct

Wi-Fi Direct devices can connect to each other without having to go through an access point. Wi-Fi Direct devices establish their own ad-hoc network when required, letting you see which devices are available and choose which one to connect to.

1. Go to **Settings**.
2. Touch **Network & internet**.
3. Touch **Internet**.
4. Slide the **Wi-Fi** switch to the **On** position.
5. Scroll down to the bottom of the screen and touch **Network preferences > Wi-Fi Direct**. The device begins searching for another Wi-Fi Direct device.
6. Touch the name of the other device.
7. On the other device, select **Accept**.

**Connected** displays on the device. On both devices, in their respective Wi-Fi Direct screens, the other device name displays in the list.

## Bluetooth

Bluetooth devices can communicate without wires, using frequency-hopping spread spectrum (FHSS) radio frequency (RF) to transmit and receive data in the 2.4 GHz Industry Scientific and Medical (ISM) band (802.15.1). Bluetooth wireless technology is specifically designed for short-range (10 m (32.8 ft)) communication and low power consumption.

Devices with Bluetooth capabilities can exchange information (for example, files, appointments, and tasks) with other Bluetooth enabled devices such as printers, access points, and other mobile devices.

The device supports Bluetooth Low Energy. Bluetooth Low Energy is targeted at applications in the fitness, security, and home entertainment industries. It provides reduced power consumption and cost while maintaining standard Bluetooth range.

## Adaptive Frequency Hopping

Adaptive Frequency Hopping (AFH) on the device is a method of avoiding fixed frequency interferers and can be used with Bluetooth voice. All devices in the piconet (Bluetooth network) must be AFH-capable for AFH to work. There is no AFH when connecting and discovering devices. Avoid making Bluetooth connections and discoveries during critical 802.11b communications.

AFH for Bluetooth consists of four main sections:

- Channel Classification - A method of detecting an interference on a channel-by-channel basis, or pre-defined channel mask.
- Link Management - Coordinates and distributes the AFH information to the rest of the Bluetooth network.
- Hop Sequence Modification - Avoids interference by selectively reducing the number of hopping channels.

When AFH is enabled, the Bluetooth radio “hops around” (instead of through) the 802.11b high-rate channels. AFH coexistence allows enterprise devices to operate in any infrastructure.

The Bluetooth radio in this device operates as a Class 2 device power class. The maximum output power is 2.5 mW and the expected range is 10 m (32.8 ft). A definition of ranges based on power class is difficult to obtain due to power and device differences, and whether in open space or closed office space.



**NOTE:** It is not recommended to perform Bluetooth wireless technology inquiry when high rate 802.11b operation is required.

## Security

The current Bluetooth specification defines security at the link level. Application-level security is not specified. This allows application developers to define security mechanisms tailored to their specific needs. Link-level security occurs between devices, not users, while application-level security can be implemented on a per-user basis. The Bluetooth specification defines security algorithms and procedures required to authenticate devices, and if needed, encrypt the data flowing on the link between the devices. Device authentication is a mandatory feature of Bluetooth while link encryption is optional.

Pairing of Bluetooth devices is accomplished by creating an initialization key used to authenticate the devices and create a link key for them. Entering a common personal identification number (PIN) in the devices being paired generates the initialization key. The PIN is never sent over the air. By default, the Bluetooth stack responds with no key when a key is requested (it is up to you to respond to the key request event). Authentication of Bluetooth devices is based upon a challenge-response transaction. Bluetooth allows for a PIN or passkey used to create other 128-bit keys used for security and encryption. The encryption key is derived from the link key used to authenticate the pairing devices. Also, the limited range and fast frequency hopping of the Bluetooth radios make long-distance eavesdropping difficult.

Recommendations are:

- Perform pairing in a secure environment.
- Keep PIN codes private and do not store the PIN codes in the device.
- Implement application-level security.

## Bluetooth Profiles

The device supports the Bluetooth services listed.

**Table 26** Bluetooth Profiles

| Profile                                    | Description   |
|--|---|
| Service Discovery Protocol (SDP)           | Handles the search for known and specific services as well as general services.   |
| Serial Port Profile (SPP)                  | Allows use of RFCOMM protocol to emulate serial cable connection between two Bluetooth peer devices. For example, connecting the device to a printer. |
| Object Push Profile (OPP)                  | Allows the device to push and pull objects to and from a push server.   |
| Advanced Audio Distribution Profile (A2DP) | Allows the device to stream stereo-quality audio to a wireless headset or wireless stereo speakers.   |

**Table 26** Bluetooth Profiles (Continued)

| Profile                                    | Description  |
|--|--|
| Audio/Video Remote Control Profile (AVRCP) | Allows the device to control A/V equipment to which a user has access. It may be used in concert with A2DP.  |
| Personal Area Network (PAN)                | Allows the use of Bluetooth Network Encapsulation Protocol to provide L3 networking capabilities over a Bluetooth link. Only PANU role is supported.   |
| Human Interface Device Profile (HID)       | Allows Bluetooth keyboards, pointing devices, gaming devices and remote monitoring devices to connect to the device.   |
| Headset Profile (HSP)                      | Allows a hands-free device, such as a Bluetooth headset, to place and receive calls on the device.   |
| Hands-Free Profile (HFP)                   | Allows car hands-free kits to communicate with the device in the car.  |
| Phone Book Access Profile (PBAP)           | Allows exchange of Phone Book Objects between a car kit and a mobile device to allow the car kit to display the name of the incoming caller; allow the car kit to download the phone book so you can initiate a call from the car display. |
| Generic Attribute Profile (GATT)           | Provides profile discovery and description services for Bluetooth Low Energy protocol. It defines how attributes are grouped together into sets to form services.  |
| HID Over GATT Profile (HOGP)               | Defines the procedures and features used by Bluetooth low energy HID Devices using GATT and Bluetooth HID Hosts using GATT.  |
| Dial Up Networking (DUN)                   | Provides a standard to access the Internet and other dial-up services over Bluetooth.  |
| Generic Access Profile (GAP)               | Use for device discovery and authentication.   |
| Object EXchange (OBEX)                     | Facilitates the exchange of binary objects between devices.  |

## Bluetooth Power States

The device Bluetooth radio is off by default.

- **Suspend** - When the device goes into Sleep mode, the Bluetooth radio stays on.
- **Airplane Mode** - When the device is placed in Airplane Mode, the Bluetooth radio is not turned off when the device is connected to a Bluetooth headset or hearing device.

## Enabling Bluetooth

This section describes the method for enabling Bluetooth.

1. Swipe down from the Status bar to open the Notification panel.
2. Touch  to turn Bluetooth on.

## Disabling Bluetooth

This section describes the method for disabling Bluetooth.

1. Swipe down from the Status bar to open the Notification panel.

2. Touch  to turn Bluetooth off.

## Discovering Bluetooth Device(s)

The device can receive information from discovered devices without pairing. However, once paired, the device and a paired device exchange information automatically when the Bluetooth radio is on.

1. Ensure that Bluetooth is enabled on both devices.
2. Ensure that the Bluetooth device to discover is in discoverable mode.
3. Ensure that the two devices are within 10 m (32.8 ft) of one another.
4. Swipe down from the Status bar to open the Quick Access panel.
5. Touch and hold **Bluetooth**.
6. Touch **Pair new device**. The device begins searching for discoverable Bluetooth devices in the area and displays them under **Available devices**.
7. Scroll through the list and select a device. The Bluetooth pairing request dialog box displays.
8. Touch **Pair** on both devices.
9. The Bluetooth device is added to the **Paired devices** list and a trusted (“paired”) connection is established.

## Changing the Bluetooth Name

By default, the device has a generic Bluetooth name that is visible to other devices when connected.

1. Go to **Settings**.
2. Touch **Connected devices > Connection preferences > Bluetooth**.
3. If Bluetooth is not on, move the switch to turn Bluetooth on.
4. Touch **Device name**.
5. Enter a name and touch **RENAME**.

## Connecting to a Bluetooth Device

Once paired, connect to a Bluetooth device.

1. Go to **Settings**.
2. Touch **Connected devices > Connection preferences > Bluetooth**.
3. In the list, touch the unconnected Bluetooth device.

When connected, **Connected** displays below the device name.

## Selecting Profiles on the Bluetooth Device

Some Bluetooth devices have multiple profiles.

1. Go to **Settings**.
2. Touch **Connected devices > Connection preferences > Bluetooth**.
3. In the **Paired Devices** list, touch  next to the device name.

4. Turn on or off a profile to allow the device to use that profile.

### Unpairing a Bluetooth Device

Unpairing a Bluetooth device erases all pairing information.

1. Go to **Settings**.
2. Touch **Connected devices > Connection preferences > Bluetooth**.
3. In the **Paired Devices** list, touch  next to the device name.
4. Touch **FORGET**.

### Cast

Use **Cast** to mirror the device screen on a Miracast enabled wireless display.

1. Go to **Settings**.
2. Touch **Connected devices > Connection preferences > Cast**.
3. Touch  > **Enable wireless display**.

The device searches for nearby Miracast devices and lists them.

4. Touch a device to begin casting.

### Near Field Communications

NFC/HF RFID is a short-range wireless connectivity technology standard that enables a secure transaction between the device and a contactless smart card.

The technology is based on ISO/IEC 14443 type A and B (proximity) ISO/IEC 15693 (vicinity) standards, using the HF 13.56 MHz unlicensed band.

The device supports the following operating modes:

- Reader mode.
- Card Emulation mode.

Using NFC, the device can:

- Read contactless cards, such as contactless tickets, ID cards, wallet passes, and ePassport.
- Read and write information to contactless cards, such as SmartPosters and tickets, as well as devices with an NFC interface, such as vending machines.
- Read information from supported medical sensors.
- Pair with supported Bluetooth devices such as printers, ring scanners (for example, RS6000), and headsets (for example, HS3100).
- Exchange data with another NFC device.
- Emulate a contactless card such as a ticket.

The device's NFC antenna is located at the top, behind the LCD display, for reading NFC cards while the device is held.

## Reading NFC Cards

Read contactless cards using the NFC antenna.

1. Launch an NFC-enabled application.
2. Hold the device as shown.
3. Align the NFC card with the NFC antenna (1) on the front of the device.

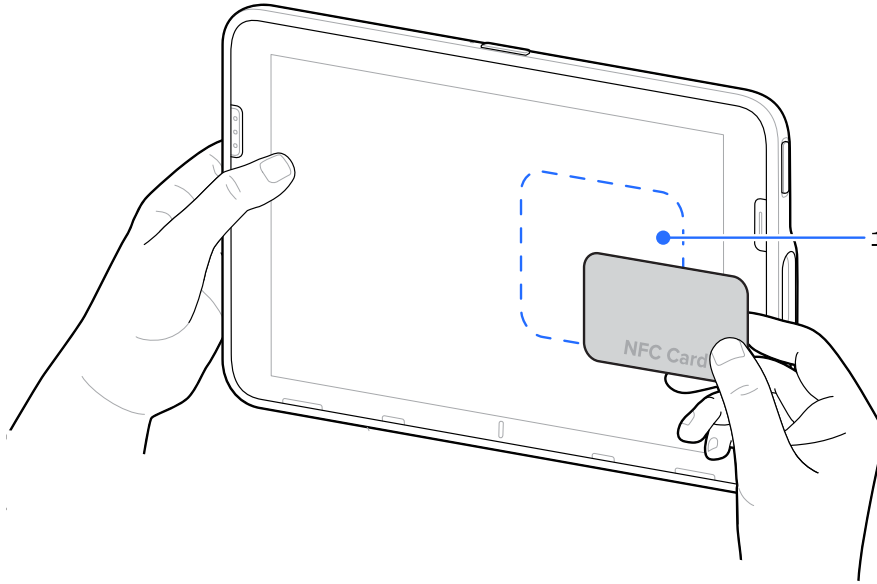

4. Hold the card steadily until the transaction is complete (usually indicated by the application).

## Enterprise NFC Settings





Improve NFC performance or increase battery life by selecting which NFC features to use on the device.

- **Card Detection Mode** - Select a card detection mode.
  - **Standard** - Provides the optimal NFC detection speed, but reduces battery life.
- **Supported Card Technology** - Select an option to detect only one NFC tag type, increasing battery life, but reducing detection speed.
  - **ISO 14443 Type A**
  - **ISO 14443 Type B**
  - **FeliCa**
  - **ISO 15693**
- **NFC Debug Logging** - Use to enable or disable debug logging for NFC.
- **Other NFC settings available with Zebra administrator tools (CSP)** - Allows configuration of additional Enterprise NFC Settings through staging tools and Mobile Device Management (MDM) solutions with an MX version that supports the Enterprise NFC Settings Configuration Service Provider (CSP). For more information on using the Enterprise NFC Settings CSP, go to: [techdocs.zebra.com/nfcmgr/](https://techdocs.zebra.com/nfcmgr/).

# Accessories

This section provides information for using the accessories for the device.

**Table 27** Device Accessories

| Accessory                                  | Part Number  | Description   |
|--|--|---|
| <b>Cradles</b>                             |  |   |
| 1-Slot Power Delivery (PD) Charging Cradle | CRD-ET4A-1SCG1-01  | Charges the main battery and the optional PowerPack installed in the Expansion Back. Requires country-specific Power Supply PWR-WUA5V45W1XX with USB-C to USB-C CBL-TN28USBC2C-01 Charging Cable.<br><br> <b>NOTE:</b> This cradle does not work with Essentials SKUs. |
| 4-Slot Charge Only Cradle                  | CRD-ET4X-4S8I1-01 (8" device)<br>CRD-ET4X-4S10I1-01 (10" device) | Requires power supply PWR-BGA12V108W0WW, DC line cord CBL-DC-388A1-01, and country-specific AC line cord.<br><br> <b>NOTE:</b> This cradle does not work with Essentials SKUs.   |
| Connect Hub                                | CRD-BLNK-1SNHP-01 (8" and 10" standard device)                   | Connectivity hub for the device. Refer to the Accessories Guide on <a href="http://zebra.com">zebra.com</a> for more information.<br><br> <b>NOTE:</b> This cradle does not work with Essentials SKUs.   |
| Connect Cradle                             | CRD-ET4X-1SNWS-02 (8" and 10" standard device)                   | Charging and docking cradle for the device. Refer to the Accessories Guide on <a href="http://zebra.com">zebra.com</a> for more information.<br><br> <b>NOTE:</b> This cradle does not work with Essentials SKUs.  |
| <b>Batteries and Chargers</b>              |  |   |



**Table 27** Device Accessories (Continued)

| Accessory  | Part Number  | Description  |
|--|--|--|
| Replacement Internal Battery                         | BTRY-ET401-08INC-01 (8" device)<br>BTRY-ET401-08INC-IN (8" device, India Only)<br>BTRY-ET401-10INC-01 (10" device)<br>BTRY-ET401-10INC-IN (10" device, India Only) | Replacement standard battery (single pack) device.   |
| PowerPack  | BTRYET5X-PRPK2-01  | Additional power for charging the device battery using an Expansion Back.  |
| 4-Slot PowerPack Battery Charger                     | SAC-ET5X-4PPK1-01  | Chargers up to four PowerPacks. Requires power supply PWR-BGA12V50W0WW, DC Line cord CBL-DC-388A1-01, and country-specific AC line cord.                         |
| <b>Charge and Communication Cables</b>               |  |  |
| USB-C Communication and Charge Cable                 | CBL-EC5X-USBC3A-01   | USB-C to USB-C cable supports data transmission and power delivery and is compatible with PCs that have USB-C ports.   |
| <b>Audio Accessories</b>                             |  |  |
| USB-C Headset  | HDST-USBC-PTT1-01  | USB-C headset with PTT and volume control for Workforce Communication. Provides wired communication with the device.   |
| Rugged Wired Headset (Over-The-Head Headband)        | HS3100-OTH   | Includes HS3100 Boom Module and HSX100 OTH Headband Module. Provides wired communication with the device.  |
| Rugged Wired Headset (Behind-The-Neck Headband Left) | HS3100-BTN-L   | Includes HS3100 Boom Module (HS3100-BOOM-01) and HSX100 behind-the-neck headband left module (HSX100-BTN-L-HB-01). Provides wired communication with the device. |
| Rugged Wired Headset (Over-The-Head Headband)        | HS3100-OTH-SB  | Includes HS3100 Shortened Boom Module and HSX100 OTH headband module. Provides wired communication with the device.  |
| Rugged Wired Headset (Behind-The-Neck Headband)      | HS3100-BTN-SB  | Includes HS3100 Shortened Boom Module and HSX100 BTN headband module. Provides wired communication with the device.  |
| Shortened Boom Module                                | HS3100-SBOOM-01  | Includes microphone boom, battery, and windscreen.   |
| <b>Carrying Solutions</b>                            |  |  |

**Table 27** Device Accessories (Continued)

| Accessory                | Part Number  | Description  |
|--------------------------|--|--|
| Breakaway Shoulder Strap | SG-ET5X-SHDRSTP-01   | Use with the rugged boot and D-clips to carry device on shoulder.  |
| Universal Shoulder Strap | 58-40000-007R  | Use with the rugged boot and D-clips to carry device on shoulder.  |
| D Clips                  | SG-ET4X-DCLIPS-01  | Replacement D-clips for use with the Breakaway Should Strap.   |
| Handle Strap             | SG-ET5X-HNDSTP-01  | Use with the rugged boot and D-clips to carry device with a hand strap.  |
| <b>Power Supply</b>      |  |  |
| Power Supply             | PWR-WUA5V45W1XX<br>Where XX is the country code (US - United States; GB - United Kingdom; ) to get the right plug style based on region. | A 45W Power Delivery (PD) power supply. Requires USB-C to USB-C CBL-EC5X-USBC3A-01 Charging Cable.   |
| <b>Stylus</b>            |  |  |
| Fiber Tipped Stylus      | SG-STYLUS-TCX-MTL-03   | Stainless steel and brass stylus with micro-knit hybrid mesh fiber tip, especially for use in rain or snow (3-pack).   |
| Plastic Stylus           | SG-TC7X-STYLUS-03  | Rigid plastic stylus optimized for enterprise durability (3- pack).  |
| <b>Miscellaneous</b>     |  |  |
| Rugged Boot              | SG-ET401-08EXO-01 (8" device)<br>SG-SG-ET401-10EXO-01 (10" device)<br>SG-ET401-08EXO-02 (8" device)<br>SG-ET401-10EXO-02 (10" device)    | Additional protection for the device.  |
| Adapter Boot             | SG-ET401-08ET5-XX (where XX is 01=black and 02=blue)   | A protective accessory enhancing durability for the device. This adapter boot enables backward compatibility with the ET5X desktop docking station and certain vehicle mounting solutions. |
| Battery Cover            | MISC-ET401-08BTC-01 (8" device)<br>MISC-ET401-10BTC-01 (10" device)  | Replacement battery cover.   |

**Table 27** Device Accessories (Continued)

| Accessory                         | Part Number   | Description  |
|-----------------------------------|---|--|
| Expansion Back (Power)            | ZBK-ET4X-8BTRYBK1-01 (8" device)<br>ZBK-ET4X-10BTRYBK1-01 (10" device)                        | Rotating hand strap and slot for optional PowerPack.   |
| Expansion Back (Payment)          | ZBK-ET4X-8PAY2500I1-01 (Ingenico Link 2500i)<br>ZBK-ET4X-8PAYPD201-01 (PD20)                  | Rotating hand strap and slot for payment device. Only available for 8" devices.<br><br> <b>NOTE:</b> Devices powered only by USB-C must have a battery installed to use the Expansion Back (Payment). |
| VESA Mount Adapter                | ZBK-ET4X-10VESA-01 (10" standard device)  | Standard VESA mounting adapter for the device.   |
| Coiled Stylus Tether              | SG-TC5NGTC7NG-TETHR-03  | Tether for stylus.<br><br> <b>NOTE:</b> Use this tether with SG-STYLUS-TCX-MTL-03 stylus.   |
| Presentation Stand                | STND-ET4X-10POS1-01 (10" standard device)   | Freestanding display stand for the device.<br><br>Refer to the Presentation Stand User Guide on <a href="https://zebra.com/support">zebra.com/support</a> for more information.  |
| Presentation Stand Battery Covers | MISC-ET4X-BTDPS-01 and MISC-ET4X-PBTDS-01 in landscape and portrait orientation respectively. | Provides a connection between the rear USB and power ports and the mounting interface of a Presentation Stand, both mechanically and electrically.   |

## Charging the Device

Before using the device for the first time, connect it to an external power source and keep it connected until fully charged. The Charging Indicator LED turns green when the device is fully charged. You can use the device while it is charging.



**NOTE:** Do not use multiple charging sources when using batteryless mode. The device may not operate properly if several power sources are connected.

The device can operate when connected to the DC input, when no battery is installed. The valid DC inputs are:

- USB-C PD input (12 VDC)
- Bottom I/O PD input (12 VDC)
- Bottom I/O 12 VDC input

- Back I/O 12 VDC input

## Charging Indicators

Charge the device's battery fully before using the device for the first time.

The 8 in. device battery charges from fully depleted to 80% in approximately 3 hours.

The 10 in. device battery charges from fully depleted to 80% in approximately 4 hours.

**Table 28** Charging Indicators

| LED   | Indication  |
|---|---|
| Off   | Device is not in the cradle; not seated properly, or cradle is not powered.   |
| Slow blinking orange<br>(1 blink every 4 seconds) | Device is charging.   |
| Slow blinking red<br>(1 blink every 4 seconds)    | Device is charging, but the battery is at the end of useful life.   |
| Fast blinking orange<br>(2 blinks/second)         | Charging error. Possible charging errors include: <ul style="list-style-type: none"> <li>• Temperature is too low or too high.</li> <li>• Charging has gone on too long without completion (typically eight hours).</li> </ul>  |
| Fast blinking red<br>(2 blinks/second)            | Charging error and the battery is at the end of useful life. Possible charging errors include: <ul style="list-style-type: none"> <li>• Temperature is too low or too high.</li> <li>• Charging has gone on too long without completion (typically eight hours).</li> </ul> |
| Solid Green                                       | Charging complete.  |
| Solid Red   | Charging is complete, but the battery is at the end of useful life.   |

## Charging Temperature

Charge batteries in ambient temperatures from 0°C to +40°C (32°F to 104°F) as reported by the battery. Charging is intelligently controlled by the charger. To accomplish this, for small periods of time, the charger alternately enables and disables battery charging to keep the battery at acceptable temperatures.

## 1-Slot Power Delivery (PD) Charging Cradle

Use a 1-Slot PD Charging Cradle to charge an 8 in. or 10 in. device.



**NOTE:** This accessory is not compatible with Essentials SKUs.

The 1-Slot PD Charging Cradle:

- Provides power for operating the device.
- Charges the device's battery and optional PowerPack installed in an Expansion Back.

**Figure 30** 1-Slot PD Charging Cradle

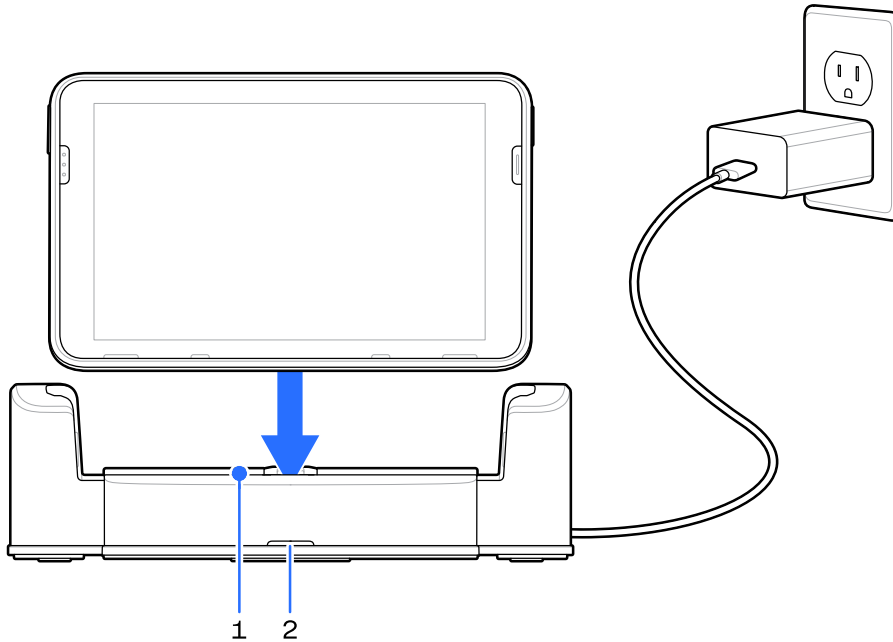

|   |                      |
|---|----------------------|
| 1 | Device charging slot |
| 2 | Power LED            |



**NOTE:** Insert the device properly in the slot to charge it.

## Setup

This section shows how to set up the cradle.

**Figure 31** 1 Slot PD Charging Cradle

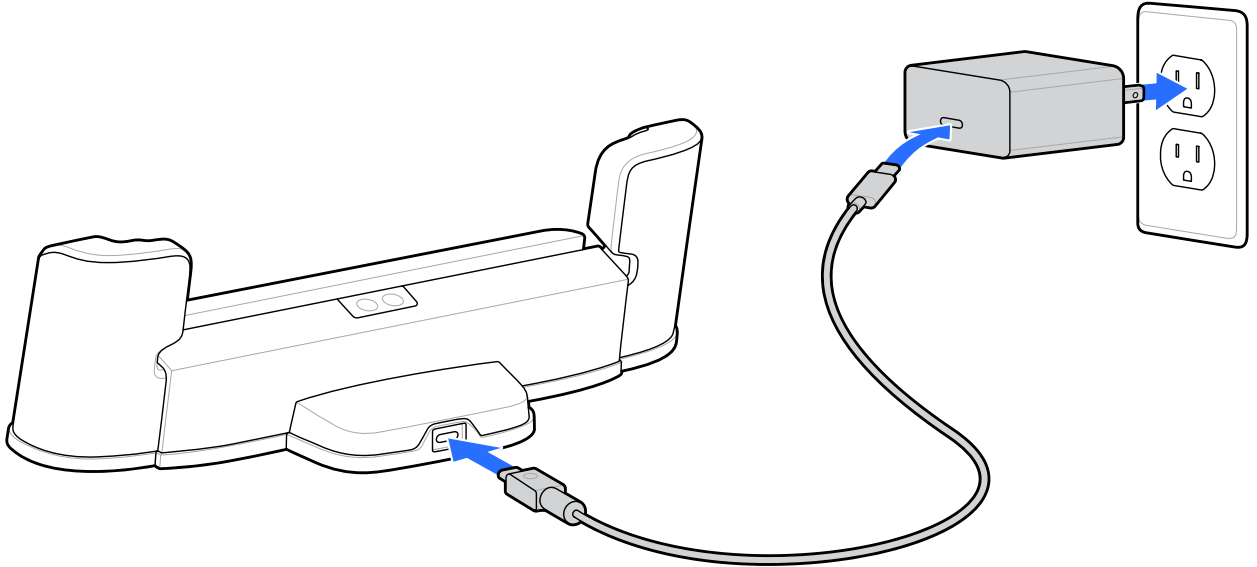

## 4-Slot Charge-Only Cradle

Use the 4-Slot Charge-Only Cradle to charge up to four 8 in. or 10 in. devices and up to four PowerPack batteries.



**NOTE:** This accessory is not compatible with Essentials SKUs.

The 4-Slot Charge-Only Cradle:

- Provides power for operating the device.
- Simultaneously charges up to four devices and up to four PowerPack batteries using the optional Battery Charger Adapter.
- There are two separate 4-Slot Charge-Only Cradles: one for 8-inch device and one for 10-inch device.

Figure 32 4-Slot Charge-Only Cradle

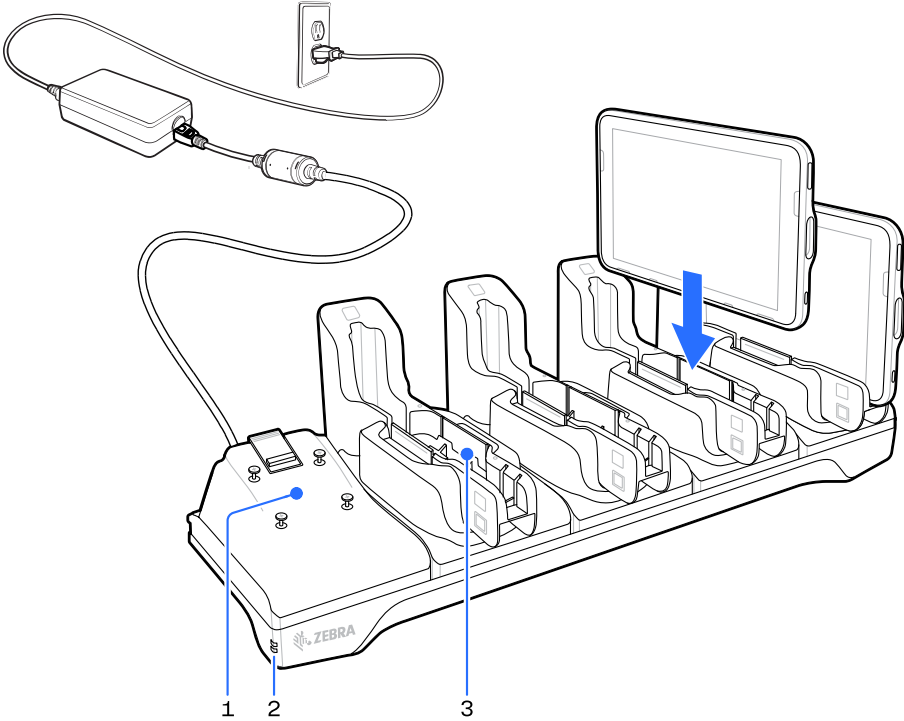

|   |                       |
|---|-----------------------|
| 1 | Battery charger mount |
| 2 | Power LED             |
| 3 | Device charging slot  |



**NOTE:** Insert the device properly in the slot to charge it.

## Setup

This section shows how to set up the cradle.

**Figure 33** 4-Slot Charge Only Cradle

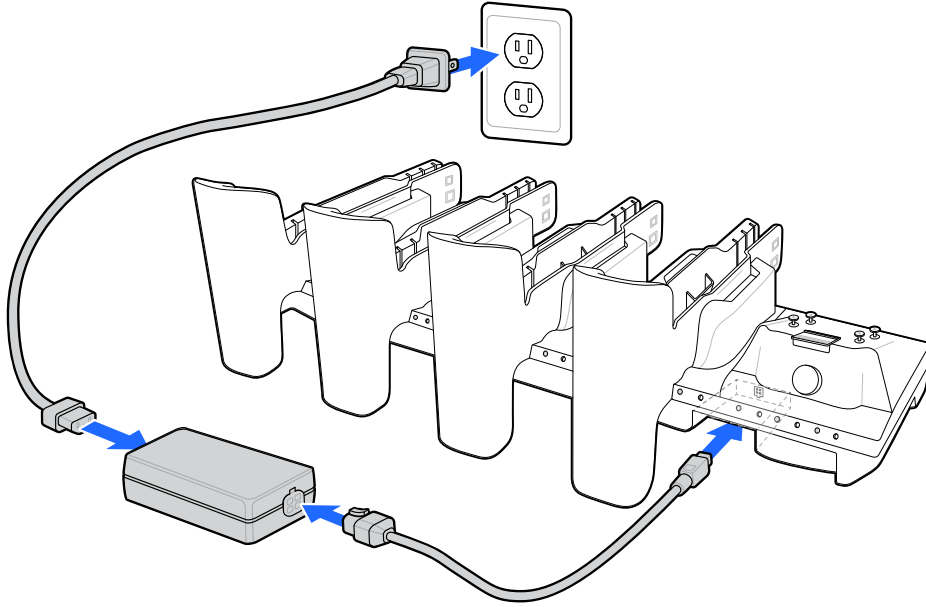

## Installing the Insert

The 4-Slot Charge-Only cradle comes with four inserts. The 8" cradle inserts are marked **S** and the 10" inserts are marked **L**. Each insert can be used with or without a device with a rugged boot, depending on how it is installed.

**Figure 34** 4-Slot Charge-Only Cradles

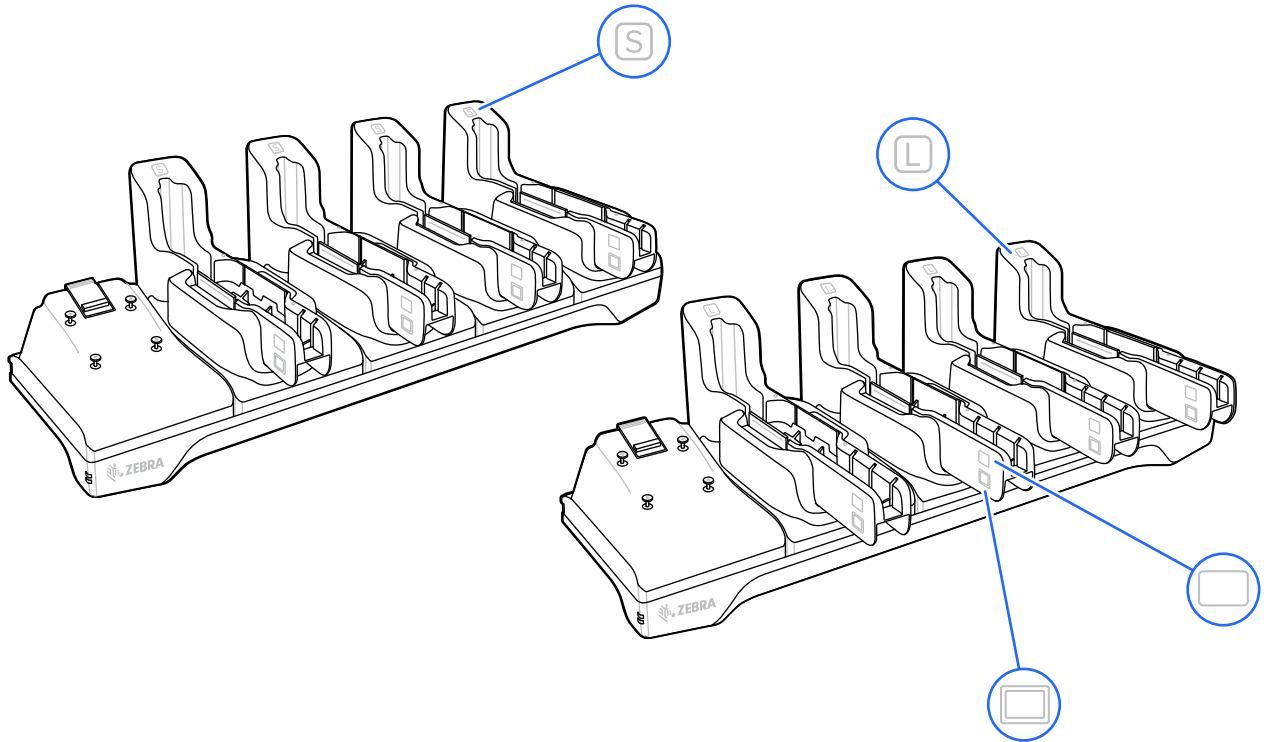

1. To charge a device without the rugged boot, hold the insert so that the device icon  is on top.

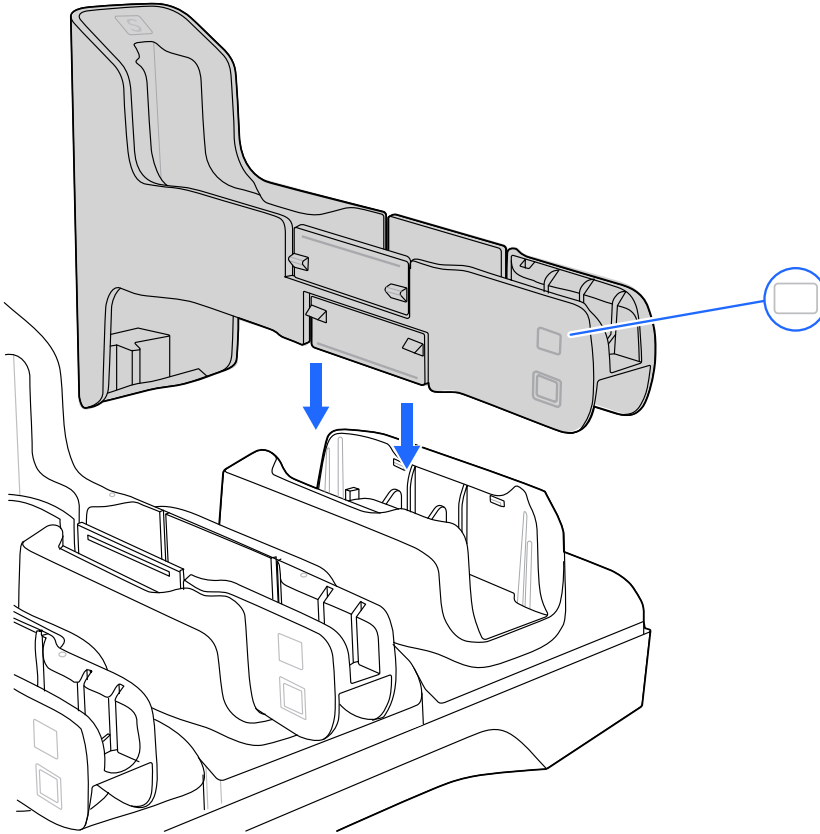

2. To charge a device with the rugged boot, hold the insert so that the rugged boot icon  is on top.

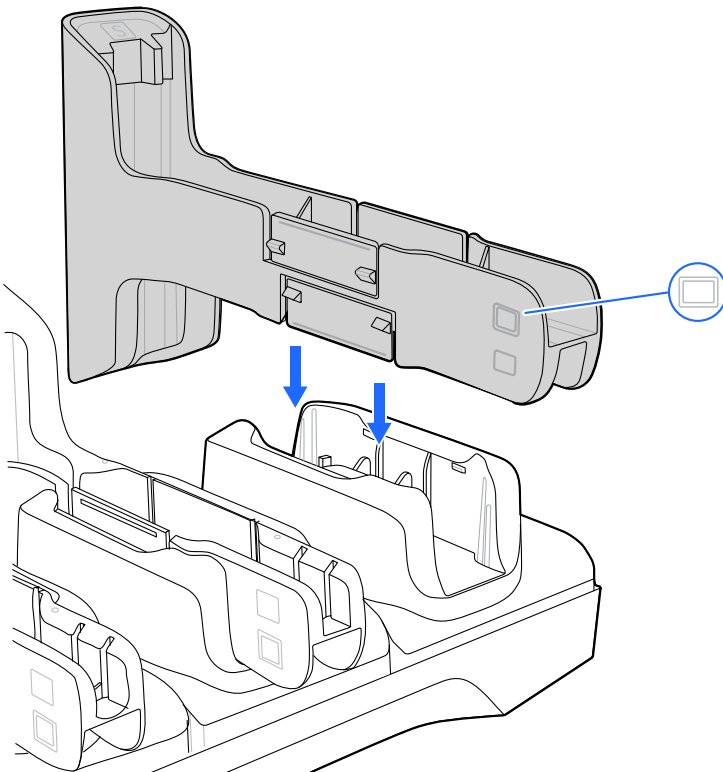

3. Align the insert with the cradle slot.
4. Press the insert down until it is fully seated.

To remove an insert, gently squeeze the tabs (1) and then lift the insert out of the cradle (2).

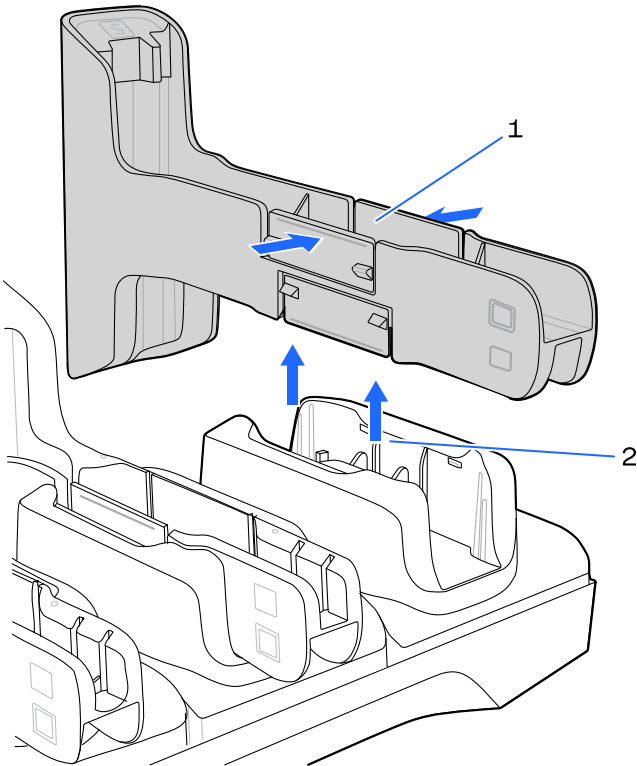

## Connect Hub

The Connect Hub is a connectivity and power interface that links peripherals to the device and Presentation Stand.

The Connect Hub enables connection to an external monitor and multiple peripherals via HDMI, RJ45 Ethernet, a 3.5mm headset jack, four USB-A ports, a 24V powered USB, and two 12V powered USB ports. It supports tablets with or without a rugged boot but is incompatible with expansion or payment backs. A locking cable cover secures and protects peripheral connections, preventing tampering or accidental disconnections.



**NOTE:** A charge and communication cable (CBL-ET4X-SCHCAB-01) connects the hub to the Presentation Stand.



**NOTE:** This accessory is not compatible with Essentials SKUs.

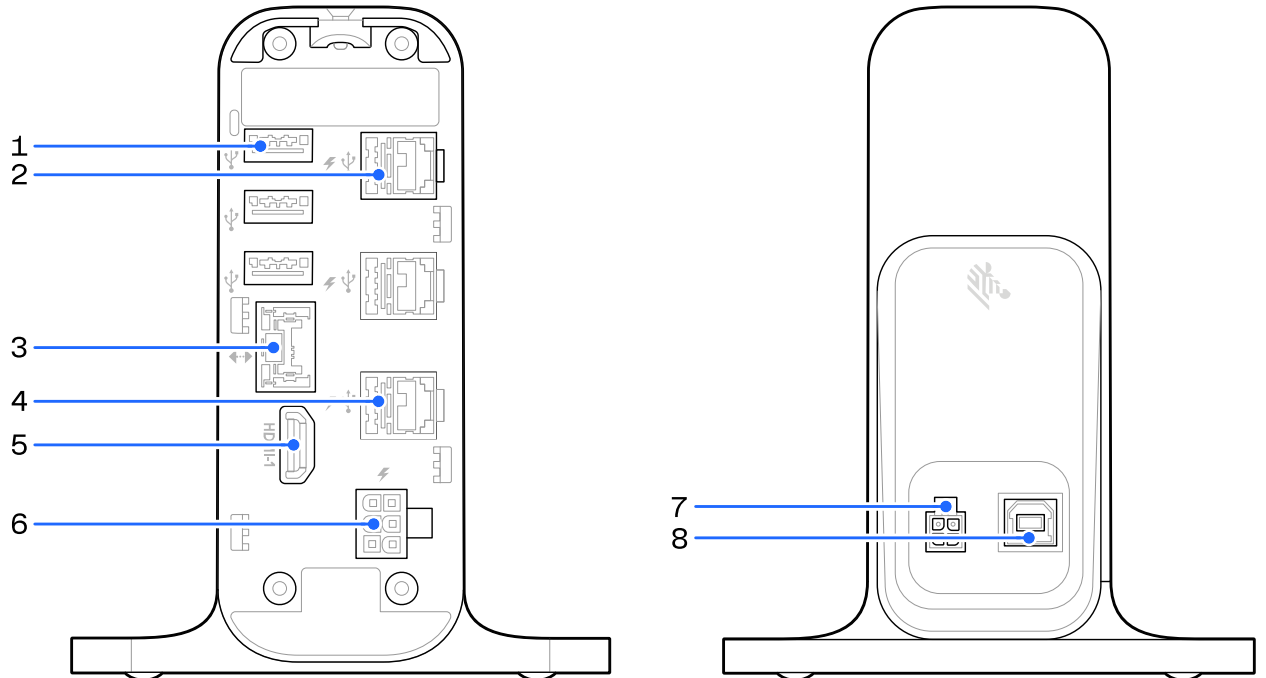

|   |                                      |
|---|--------------------------------------|
| 1 | USB 2.0 Type A 5V (3)                |
| 2 | 24V Powered USB (1)                  |
| 3 | Ethernet                             |
| 4 | 12V Powered USB (2)                  |
| 5 | HDMI                                 |
| 6 | 6-pin Connector for 24V Power Supply |
| 7 | USB Type B                           |
| 8 | 12V Power DC                         |

### Inserting the Device into the Connect Hub Cradle

This section describes the method to install the device into the Connect Hub Cradle.

Insert the device into the Connect Hub

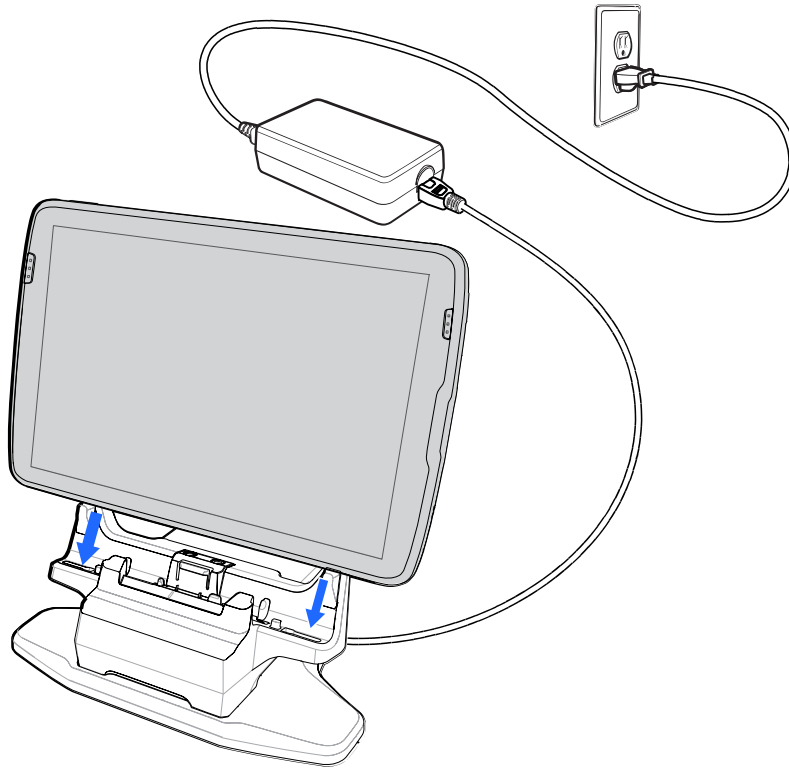

Cradle.

## PowerPack

The optional device PowerPack provides additional power to charge the main battery.



**NOTE:** This accessory is not compatible with Essentials SKUs.

**Figure 35** PowerPack

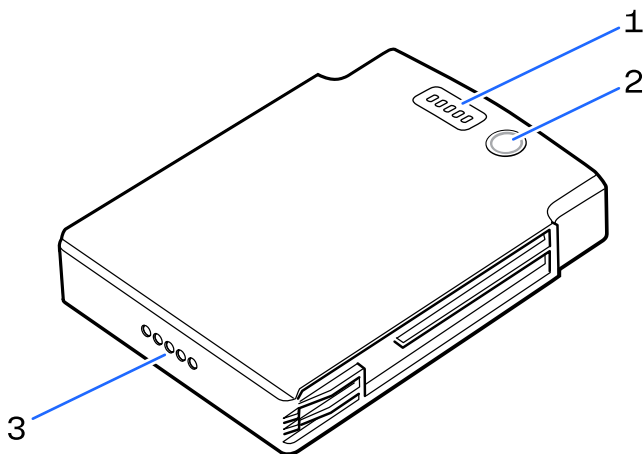

|   |                         |
|---|-------------------------|
| 1 | Charge level indicators |
|---|-------------------------|

|   |                         |
|---|-------------------------|
| 2 | Charge indicator button |
| 3 | Power output contacts   |



**NOTE:** When using a device with an installed PowerPack, you must press the PowerPack's Charge Indicator to initiate charging the device and PowerPack.



**NOTE:** When you plug in the device via USB-C, it charges the internal battery to 90% first, and then charges the external PowerPack simultaneously with the remaining 10% of the internal battery.



**NOTE:** The PowerPack does not charge via USB-C when connected to a non-Zebra-approved PD charging adapter.

### Installing the PowerPack

The PowerPack fits into the device Expansion Back.

1. Install one of the optional Expansion Backs. See [Expansion Back](#) for more information.
2. Press the two release buttons (1) on the side of the Expansion Back (3). The dummy battery insert ejects slightly.

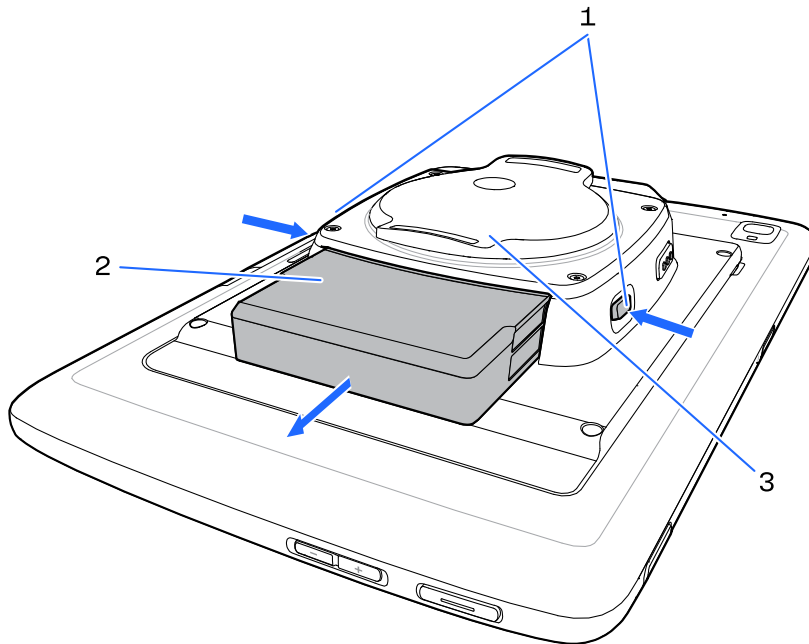

3. Remove dummy battery insert (2).
4. Insert PowerPack into slot until it snaps into place.

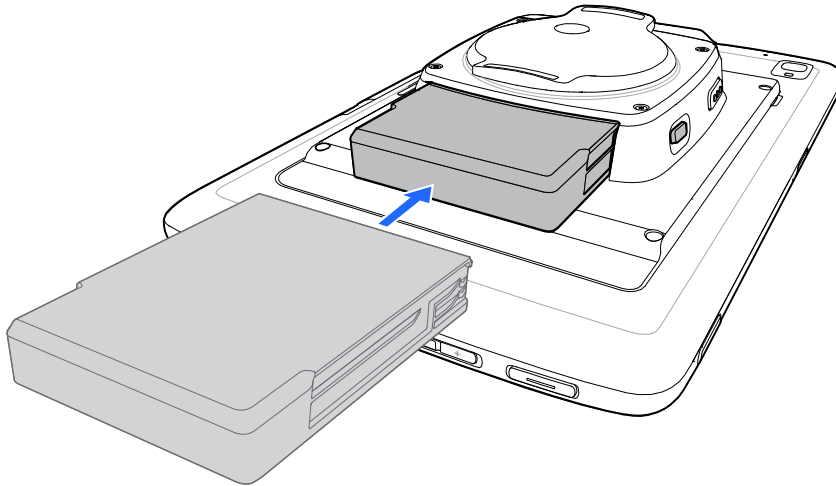

### PowerPack Charging Indicators

Charge the PowerPacks in ambient temperatures from 0°C to +40°C (32°F to 104°F) as reported by the PowerPack. Charging is intelligently controlled by the charger. To accomplish this, for small periods of time, the charger alternately enables and disables PowerPack charging to keep the battery at acceptable temperatures.

The PowerPack charge LED shows the status of the battery charging. The PowerPack charges in less than three hours. When charging, the Charge LEDs indicate the charge level.

**Figure 36** PowerPack Charge LEDs

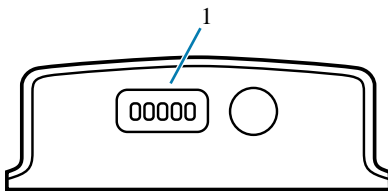





|   |                         |
|---|-------------------------|
| 1 | Charge level indicators |
|---|-------------------------|

**Table 29** PowerPack Charge Status Indicators

| PowerPack Indicators | Description                          |
|----------------------|--------------------------------------|
| ●                    | Solid Green LED                      |
| ●                    | Blinking Green LED                   |
| ●                    | Blinking Red LED                     |
| □□□□□                | Power not applied to PowerPack.      |
| □□□□●                | Charge level is between 0% and 20%.  |
| □□□●●                | Charge level is between 20% and 40%. |

**Table 29** PowerPack Charge Status Indicators (Continued)

| PowerPack Indicators  | Description                           |
|---|---------------------------------------|
|  | Charge level is between 40% and 60%.  |
|  | Charge level is between 60% and 80%.  |
|  | Charge level is between 80% and 100%. |
|  | Fully charged.                        |
|  | Charging error.                       |



**NOTE:** The PowerPack's charge status indicators are not active when the device is charging via the USB-C cable.

## 4-Slot PowerPack Battery Charger

Use the 4-Slot PowerPack Battery Charger to charge up to four PowerPack batteries.

The 4-Slot PowerPack Battery Charger:

- Provides 12 VDC power for charging the PowerPack batteries.
- Simultaneously charges up to four PowerPack batteries.

**Figure 37** 4-Slot PowerPack Battery Charger

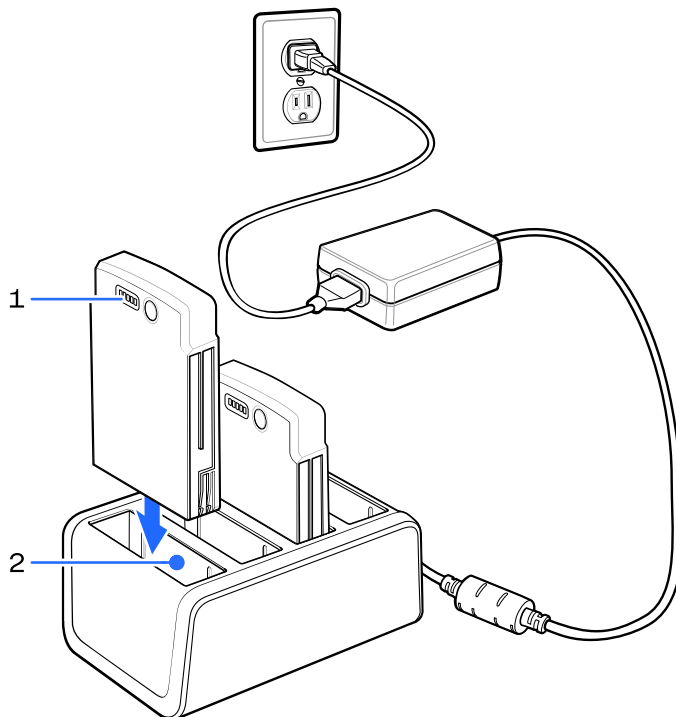

|   |                    |
|---|--------------------|
| 1 | Battery charge LED |
| 2 | Battery slot       |



**NOTE:** Insert the PowerPack battery properly in the slot to charge it.

## Setup

This section provides the device 4-Slot PowerPack Battery charger setup information.

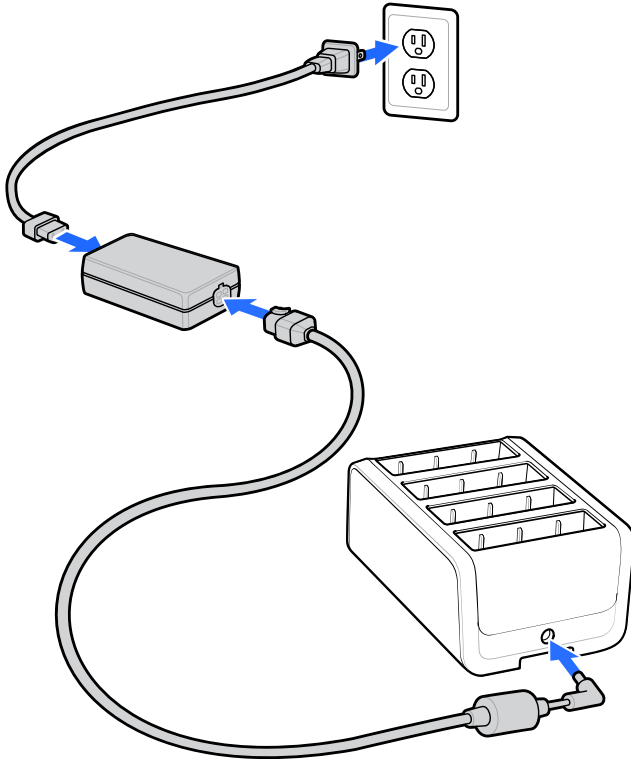

## Installing the 4-Slot PowerPack Battery Charger

The 4-Slot PowerPack Battery Charger is optional and allows charging of up to four batteries.

1. Align the mounting holes on the bottom of the charger with the four studs on the cradle.

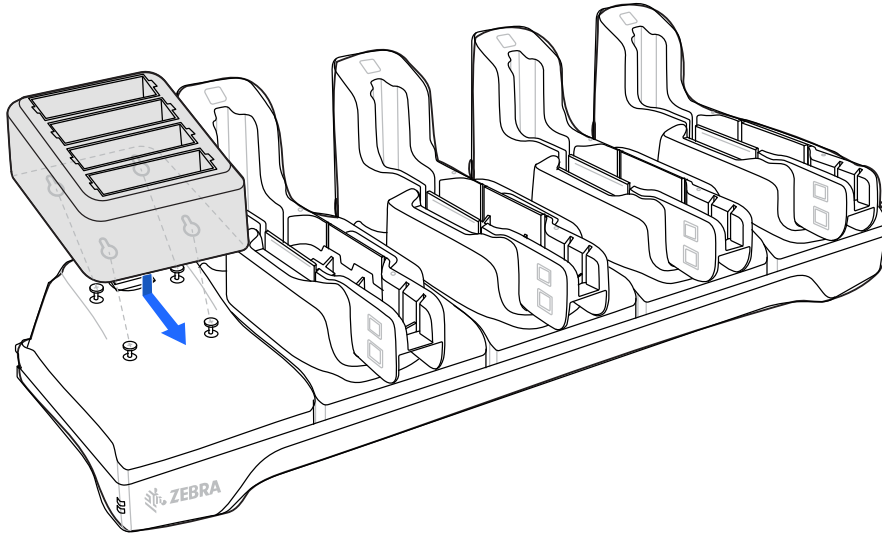

2. Place the charger on the cradle and then slide it toward the front of the cradle.

## Rugged Boot

The rugged boot provides additional protection for the device.

### Installing the Rugged Boot

This section describes the method for installing the rugged boot onto the device.

1. Insert one side of the device into the rugged boot.

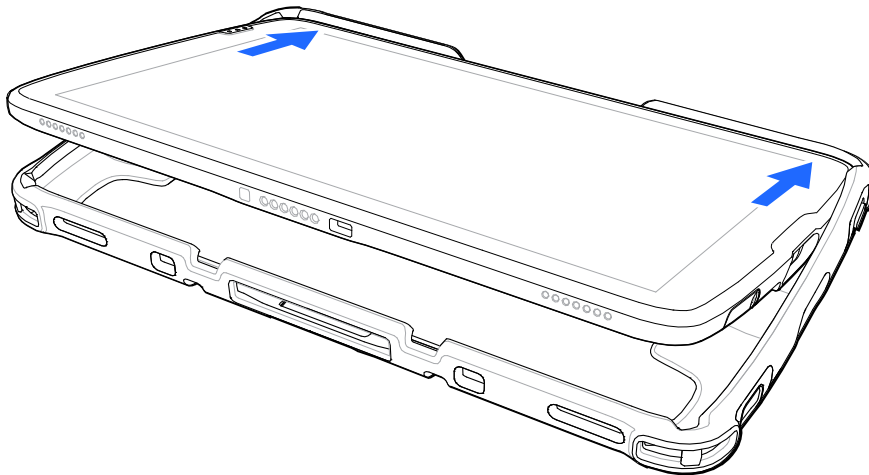

2. Push the other side of the device into the rugged boot.

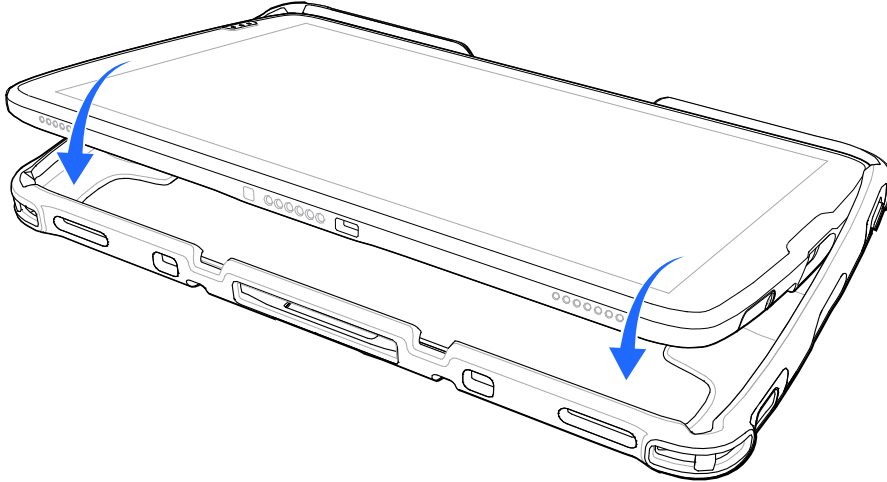

## Adapter Boot

The adapter boot offers enhanced durability and shielding for the connectors. Additionally, it allows the ET401 to be used with legacy ET5X series accessories, such as vehicle cradles and docks.

### Installing the Adapter Boot

This section describes the method for installing the adapter boot onto the device.



**NOTE:** This feature is for Standard and Premium SKUs only.

1. Vertically insert the pogo pin frame into the rear housing.

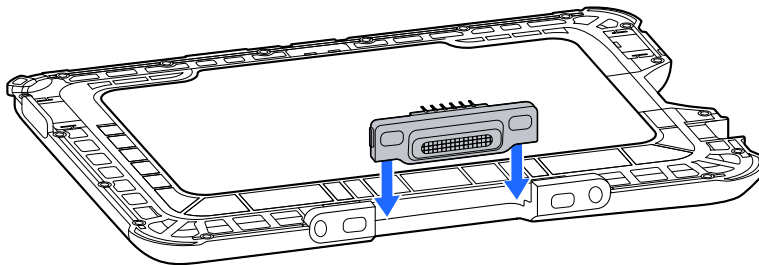

2. Ensure the alignment of all four positions.

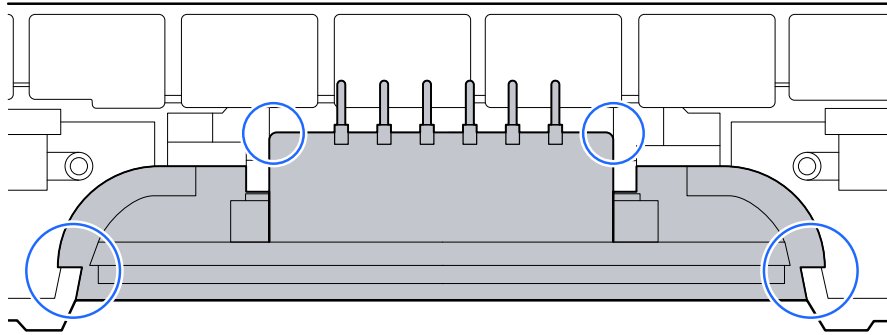

3. Tilt the device at an angle and place it into the rear housing.

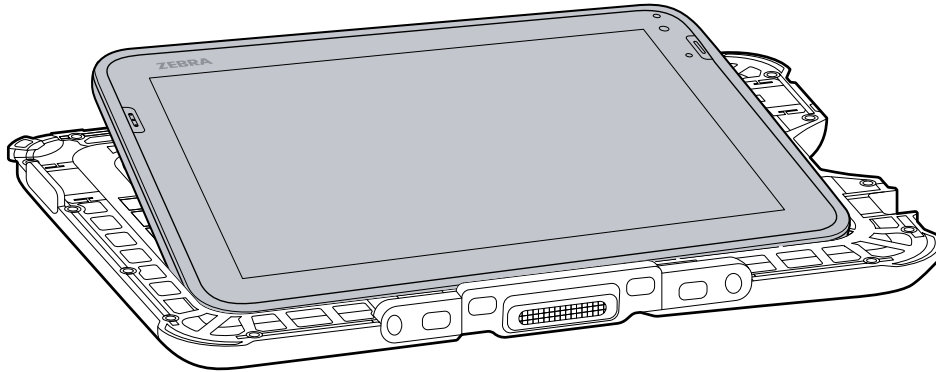

4. Verify the alignment of the device charge pad and pogo pin.

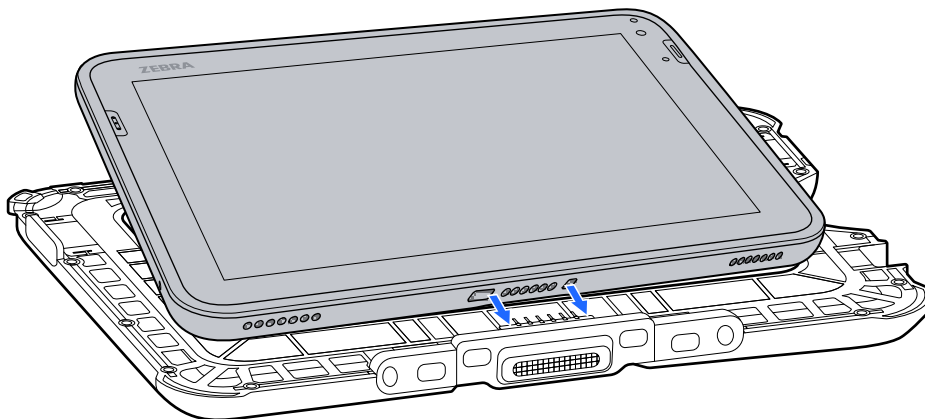

5. Install the front housing vertically, ensuring scanner position alignment.



**NOTE:** Ensure that the buttons on the left and right sides of the device are properly aligned before assembling the Top Boot cover.

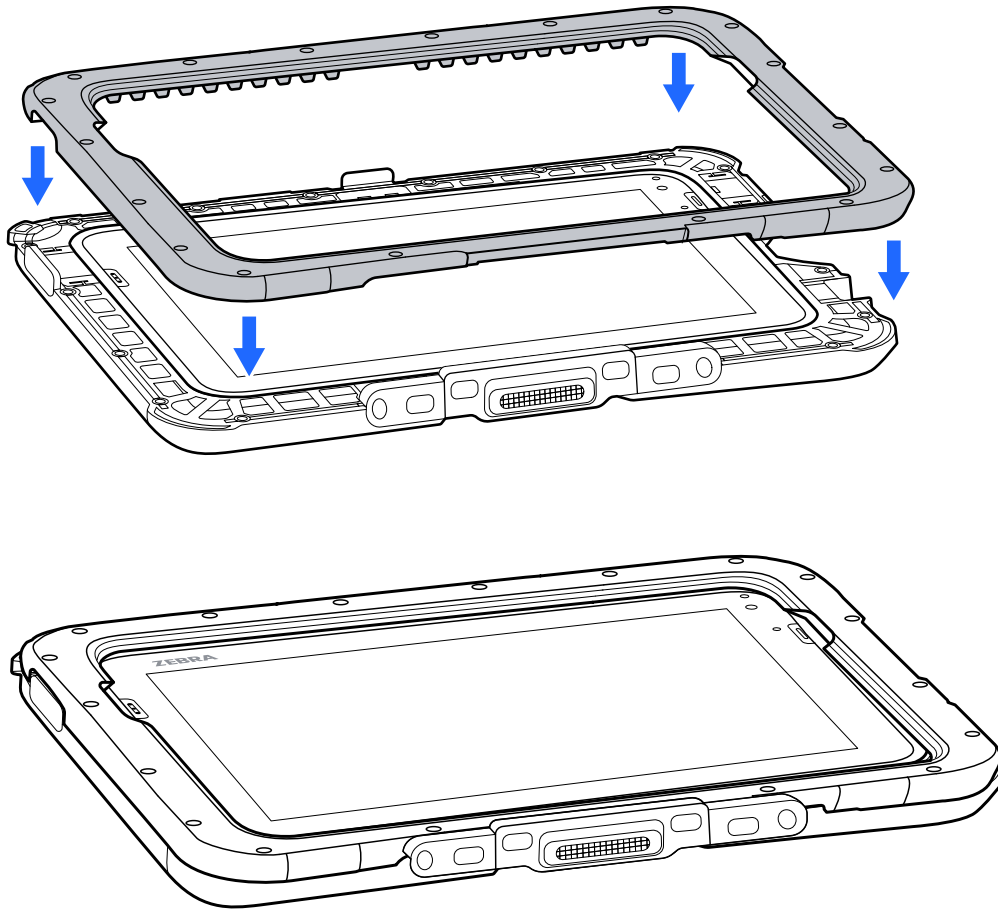

6. Use 18 M2 screws to lock the components together, and adjust the torque of the screwdriver to 1.22 kgf-cm (1.06 lbf-in). Start by securing one screw in each corner to prevent misalignment, and then tighten the remaining screws.

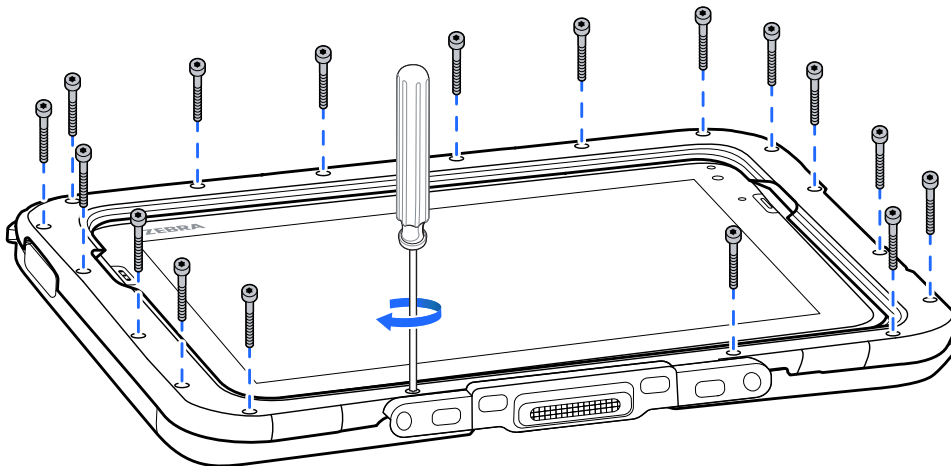

7. Insert the extra USB into the device.

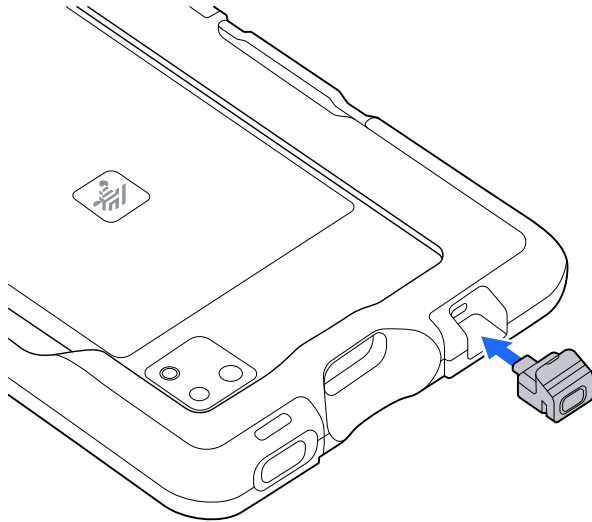

## D-Clips

Attach the D-Clips to the rugged boot on the device either in portrait or landscape orientation.

**Figure 38** D-Clips - Portrait

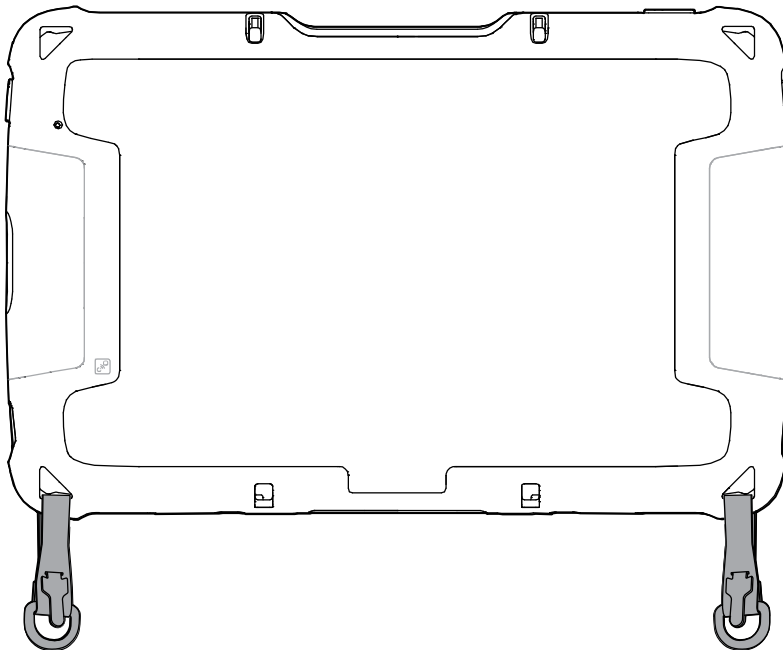

**Figure 39** D-Clips - Landscape

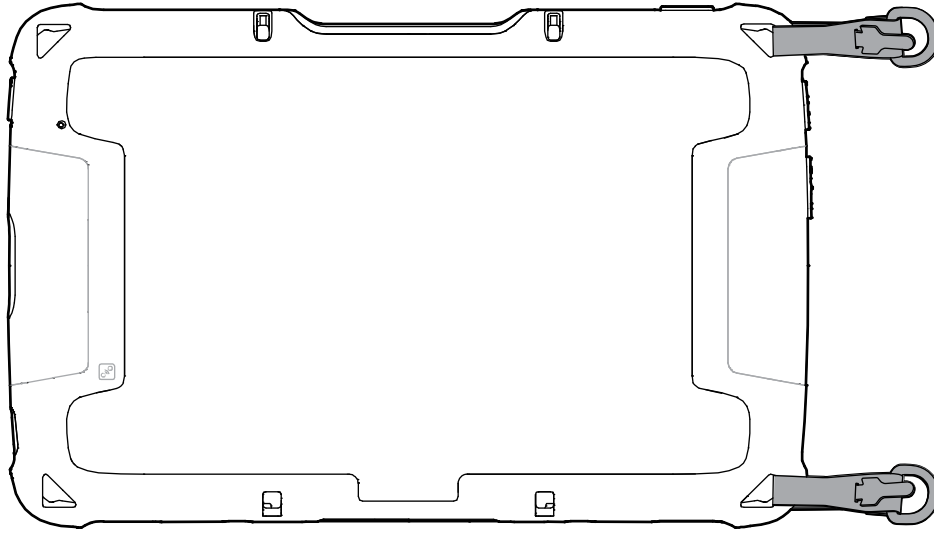

### **Attaching the Shoulder Strap**

The Shoulder Strap attaches to the D-Clips and allows you to sling the device over the shoulder.

The D-Clips must be attached to the rugged boot.

- Attach either end of the shoulder strap to each D-Clip.

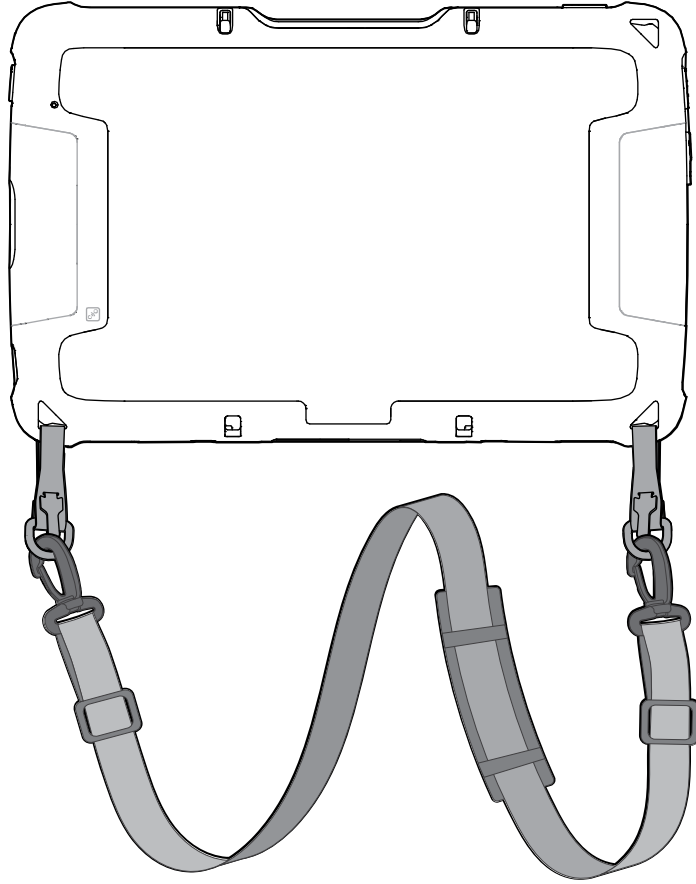

## Expansion Back

The Expansion Back provides a handstrap and PowerPack slot for the device.

### Installing the Expansion Back



**NOTE:** This accessory is not compatible with Essentials SKUs.



**CAUTION:** Power off the device before installing or removing the Expansion Back.



**CAUTION:** Do not use any tool for battery cover removal. Puncturing the battery or seal may cause a hazardous condition and a potential risk of injury.

1. Hold the device down with one hand and lift the corner of the battery cover up from the notched area.



**CAUTION:** Do not use any tool for battery cover or battery removal. Puncturing the battery or seal may cause a hazardous condition and a potential risk of injury.

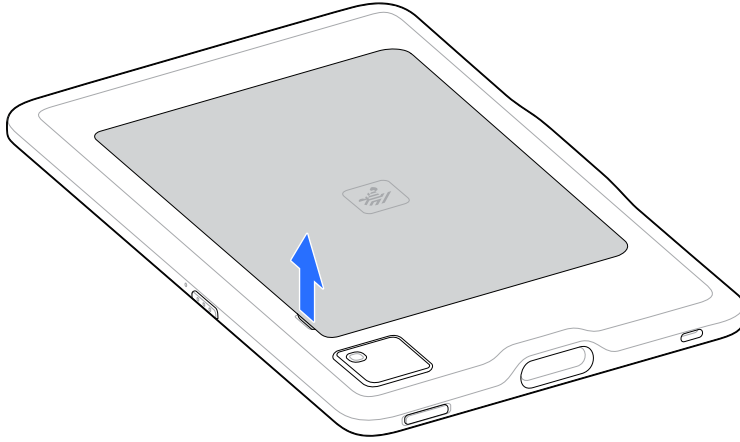

2. Place your thumb under the cover and slide your thumb along the short edge of the cover toward the other side.

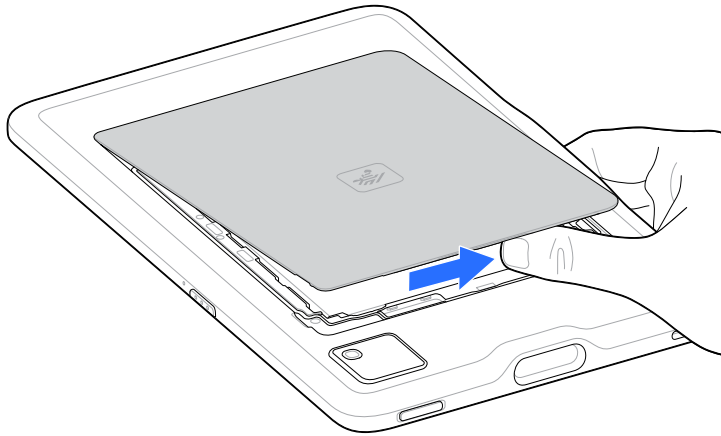

3. Carefully lift the edges of the cover, releasing the clips.

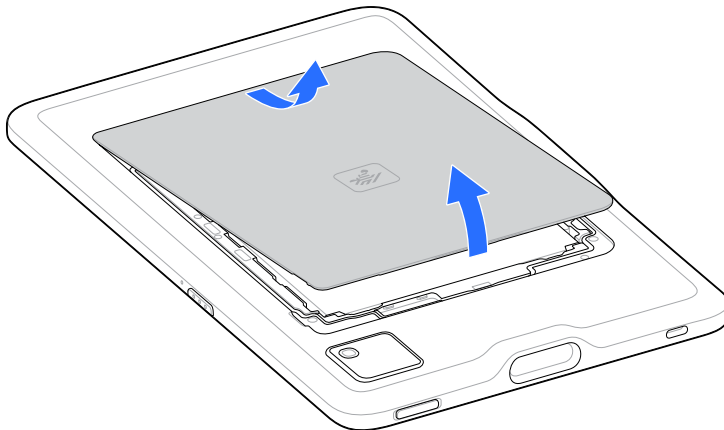

4. Remove the battery cover and store it in a safe place.
5. Insert the tabbed end of the expansion back into the battery well (1). Ensure that the tabs on the expansion back are aligned with the slots in the battery well.

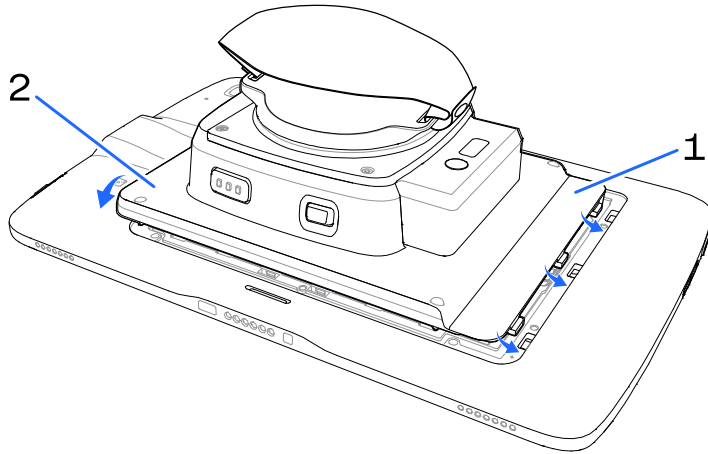

6. Rotate the expansion back down into the battery well (2).
7. Using a T5 Torx screwdriver, secure expansion back to the device using four M2 screws. Torque to 0.43 N-m (3.8 lbf-in).

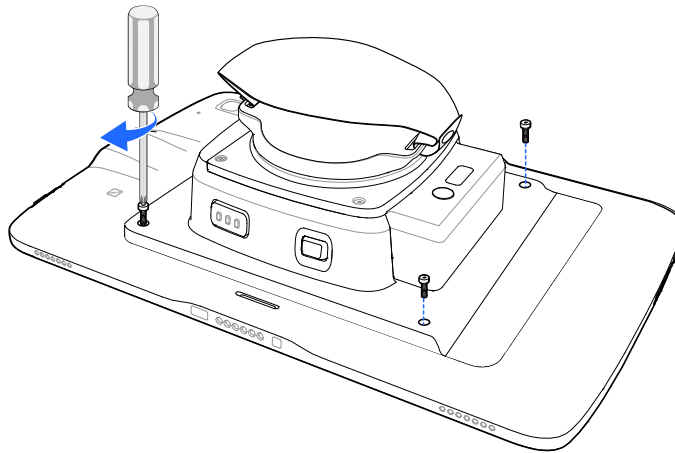

## Removing the Expansion Back

Follow this procedure to safely remove the Expansion Back.



**CAUTION:** Power off the device before removing the Expansion Back.

1. Using a T5 Torx screwdriver, remove four screws securing expansion back to the device.

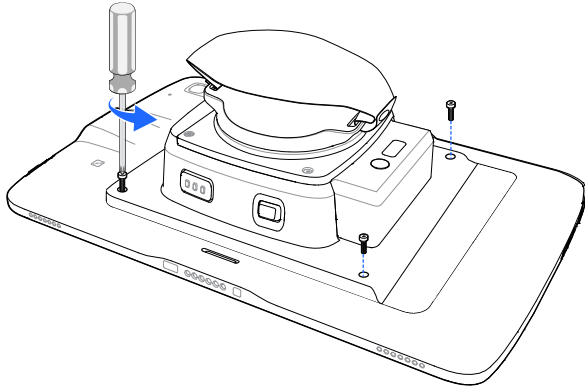

2. Lift Expansion Back off the device.
3. Insert the tabbed end of the battery cover into the slots in the battery well.
4. Rotate the cover down.

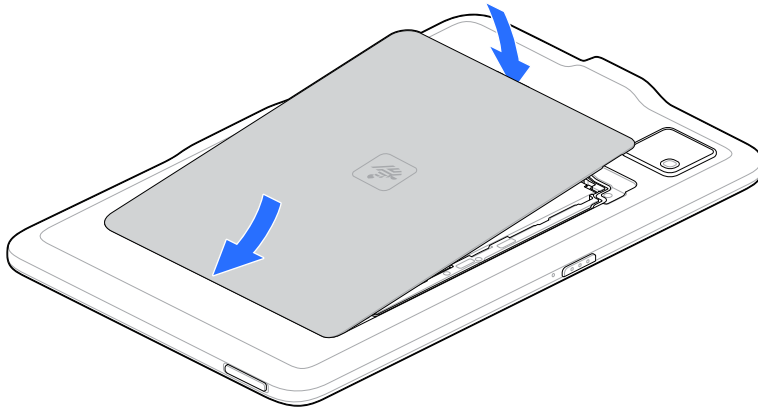

5. Carefully press down around the edges of the cover. Make sure that the cover is seated properly.

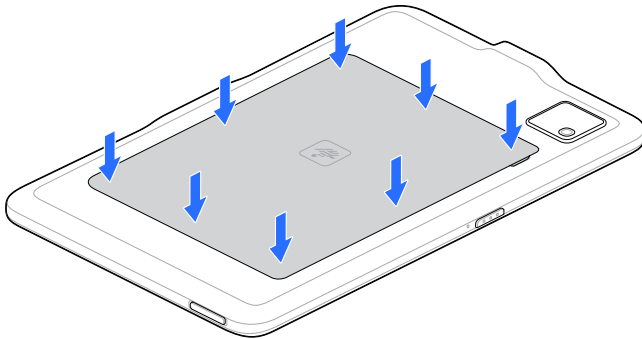

6. Press **Power** to turn on the device.

### Replacing the Hand Strap

This section describes the method for replacing the expansion back hand strap.

1. If the PowerPack is installed, remove the PowerPack.
2. Rotate the disk so that the strap end without the eyelet is aligned with the PowerPack opening.

3. Open both ends of the hand strap.

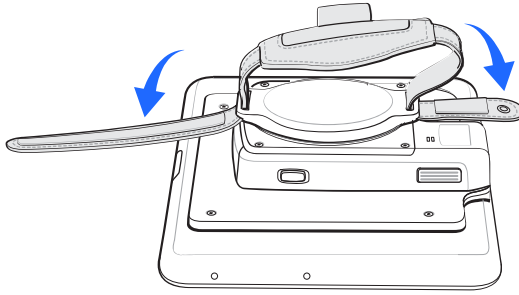

4. Pull the strap end without the eyelet through the slot on the Expansion Back.

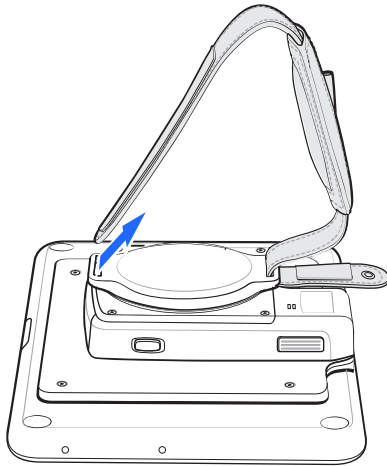

5. Rotate the disk 180°.
6. Slide the pad off the hand strap.

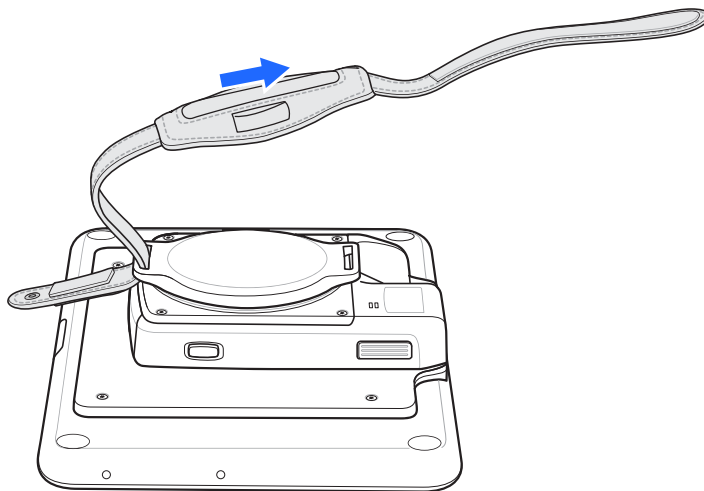

7. Pull the eyelet (1) end through the slot (2) on the Expansion Back.

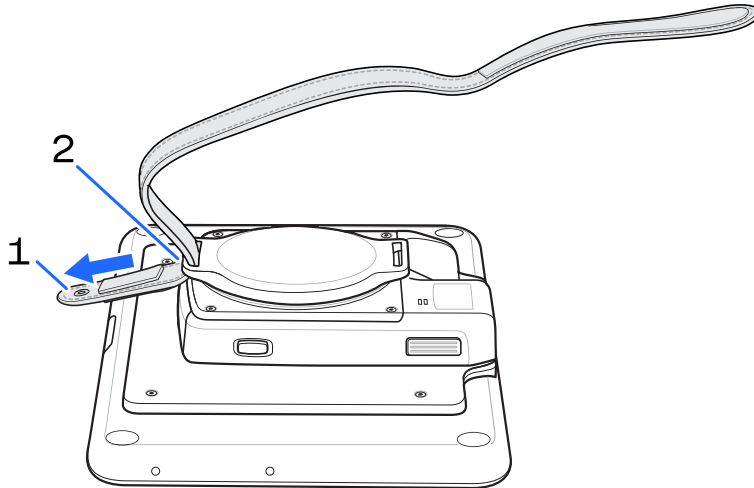

8. Remove pad from new replacement hand strap.
9. Rotate the disk (3) so that one of the slots is aligned with the PowerPack opening (4).
10. Feed the new hand strap (1) through the slot (2) at the PowerPack opening (4).

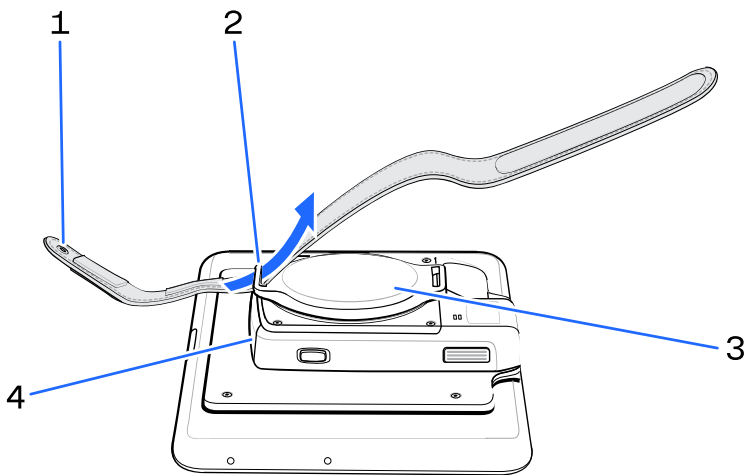

11. Slide pad (1) onto hand strap with the stylus holder (2) facing up.
12. Fold the eyelet end of the strap up and press hook and loop material together.

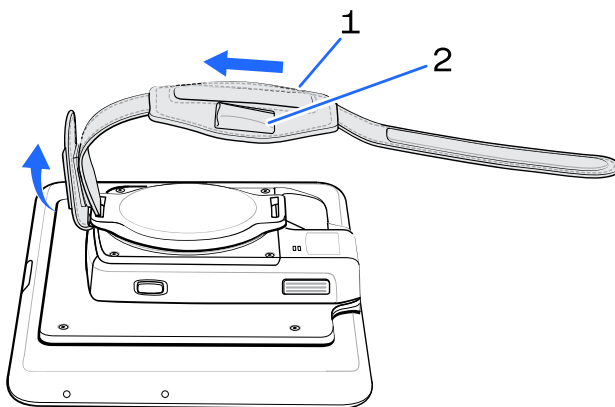

13. Rotate disk 180° so that the empty slot is aligned with the PowerPack opening.
14. Feed strap through the slot.

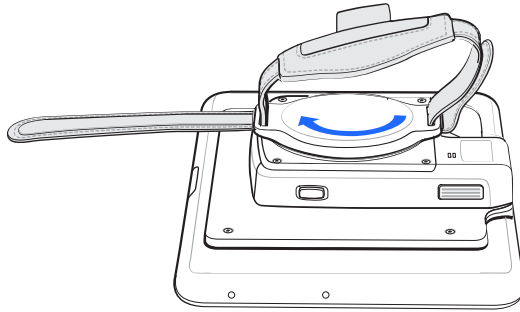

15. Fold the end of the strap up and press hook and loop material together.

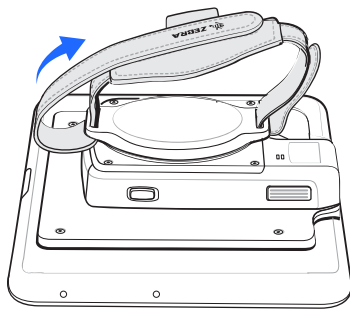

## VESA Mount

VESA Mount comes with a VESA Pattern and DC power input and replaces the existing battery cover and screws down to the back of a device.

### Installing the VESA Mount

This section describes the method for installing the device onto a VESA mount.



**NOTE:** This accessory is not compatible with Essentials SKUs.



**CAUTION:** Power off the ET4X before installing or removing the VESA Mount.



**CAUTION:** Do not use any tool for battery cover removal. Puncturing the battery or seal may cause a hazardous condition and a potential risk of injury.

1. Press and hold the Power button until the menu appears. Touch **Power off**.
2. Hold the device down with one hand and lift the corner of the battery cover up from the notched area.



**CAUTION:** Do not use any tools for battery cover or battery removal. Puncturing the battery or seal may cause a hazardous condition and a potential risk of injury.

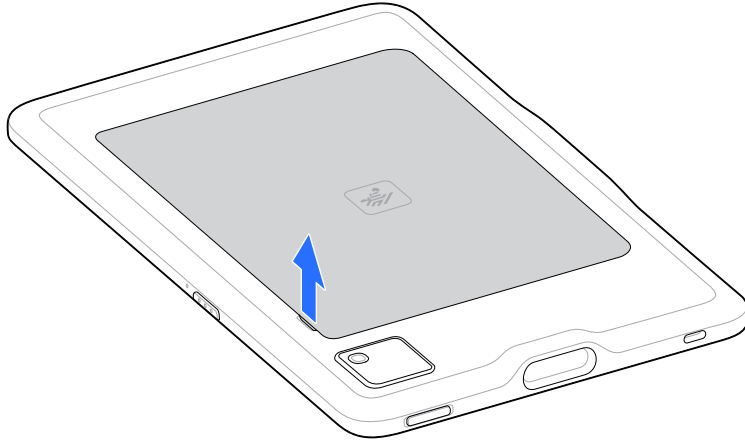

3. Place your thumb under the cover and slide your thumb along the short edge of the cover toward the other side.

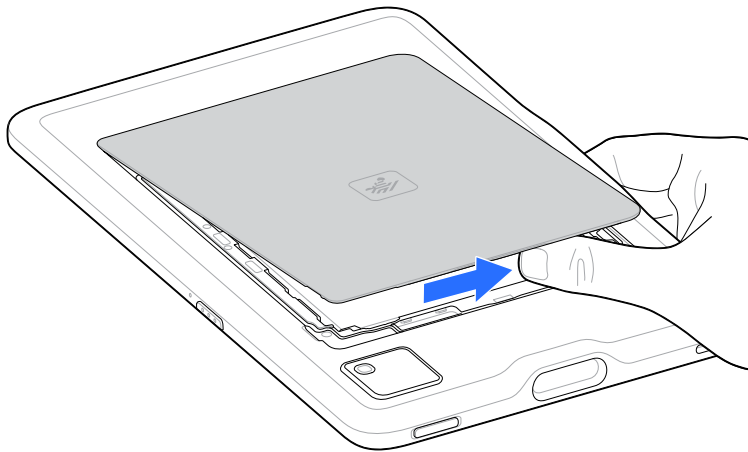

4. Carefully lift the edges of the cover, releasing the clips.

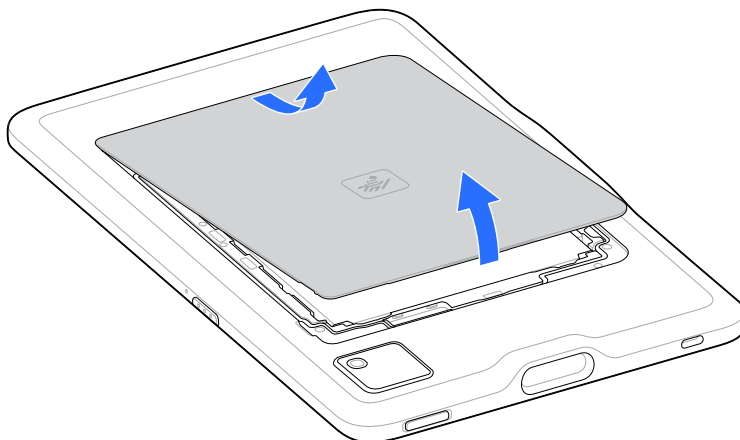

5. Remove the cover from the back housing.
6. If you are using a Zebra DC line cord (CBL-DC-388A2-01, not included) and power supply (PWRBGA12V50W0WW), remove and discard the tape securing the clip to the connector.

If you are using a third-party power supply, remove and discard tape, and keep clip in a secure place for possible future use with a Zebra DC line cord and power supply.

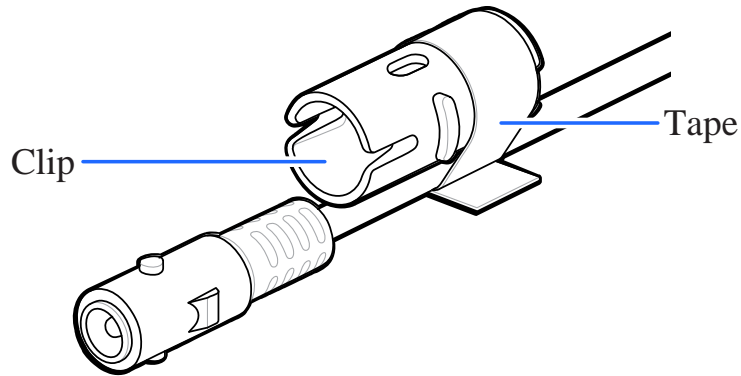

7. Insert the tabbed end of the VESA mount into the battery well. Ensure that the tabs on the VESA mount are aligned with the slots in the battery well.

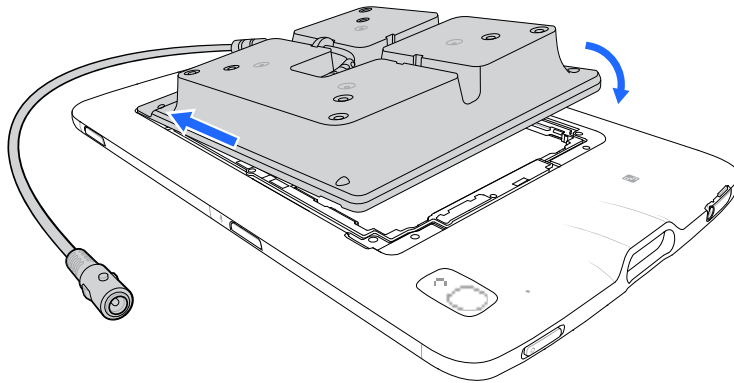

8. Rotate the VESA mount down into the battery well.
9. Carefully press down around the edges of the VESA mount. Make sure that the cover is seated properly.
10. Using a T5 Torx screwdriver, secure the VESA mount to the device using four M2 screws. Torque to 0.43 N-m (3.8 lbf-in).

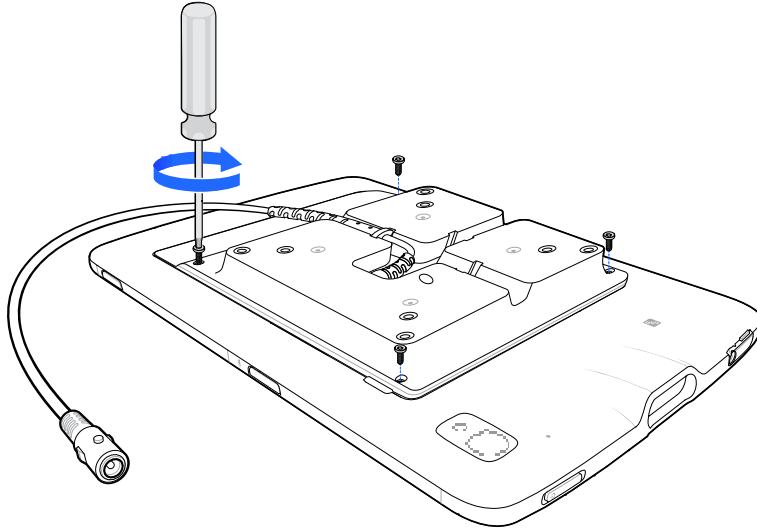

11. Determine the desired mounting orientation and reroute the power cable as required. The VESA mount supports portrait and landscape mounting and provides three cable routing slots.

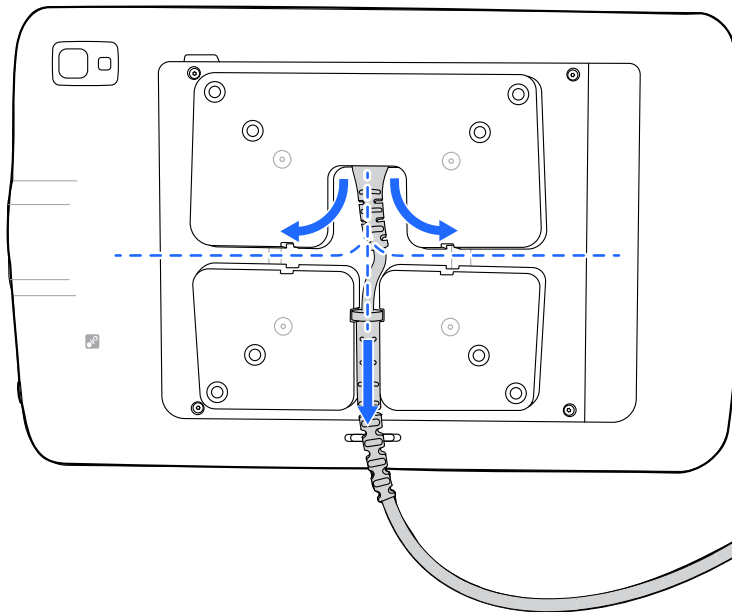

12. Mount the device using the included M4 screws. The ET4X VESA mount supports 75 mm (2.95 in.) or 100 mm (3.93 in.) mounting patterns.
13. If you are using a Zebra DC line cord and power supply, attach the provided cable clip to the VESA mount power cable connector.



**NOTE:** Do not attach the clip if using a third party power supply.

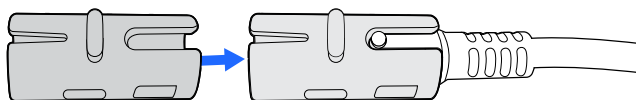

14. Plug the DC line cord connector to the VESA mount cable connector and clip.

## Accessories

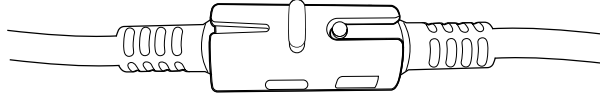

If you are using a third-party power supply, secure the cable connectors using cable ties or tape.

# Application Deployment

This section provides steps on device security, app development, and app management. It also provides instructions for installing apps and updating the device software.



**NOTE:** Ensure that the date is set correctly before installing certificates or when accessing secure websites.

## Android Security

The device implements a set of security policies that determine whether an application is allowed to run and, if allowed, with what level of trust. To develop an application, you must know the security configuration of the device and how to sign an application with the appropriate certificate to allow the application to run (and to run with the needed level of trust).



**NOTE:** Ensure the date is set correctly before installing certificates or when accessing secure websites.

## Secure Certificates

If the VPN or Wi-Fi networks rely on secure certificates, obtain the certificates and store them in the device's secure credential storage before configuring access to the VPN or Wi-Fi networks.

If downloading the certificates from a website, set a password for the credential storage. The device supports X.509 certificates saved in PKCS#12 key store files with a .p12 extension (if key store has a .pfx or other extension, change to .p12).

The device also installs any accompanying private key or certificate authority certificates contained in the key store.

## Installing a Secure Certificate

If required by the VPN or Wi-Fi network, install a secure certificate on the device.

1. Copy the certificate from the host computer to the root of the device's internal memory. See [USB Communication](#) for information about connecting the device to a host computer and copying files.
2. Go to **Settings**.
3. Touch **Security > Encryption & credentials**.
4. Touch **Install a certificate**.
5. Select the desired certificate type.

6. Navigate to the location of the certificate file.
7. Touch the filename of the certificate to install.
8. If prompted, enter the password for credential storage. If a password has not been set for the credential storage, enter a password for it twice, and then touch **OK**.
9. If prompted, enter the certificate's password and touch **OK**.
10. Enter a name for the certificate and in the Credential use drop-down, select **VPN and apps** or **Wi-Fi**.
11. Touch **OK**.

## Android Development Tools

Development tools for Android include Android Studio, EMDK for Android, and StageNow.

### Android Development Workstation

Android development tools are available at [developer.android.com](http://developer.android.com).

To start developing applications for the device, download Android Studio. Development can take place on a Microsoft® Windows®, Mac® OS X®, or Linux® operating system.

Applications are written in Java or Kotlin, but compiled and executed in the Dalvik virtual machine. After the Java code is compiled cleanly, the developer tools make sure the application is packaged properly, including the AndroidManifest.xml file.

Android Studio contains a full featured IDE as well as SDK components required to develop Android applications.

### Enabling Developer Options

The **Developer options** screen sets development-related settings. By default, the Developer Options are hidden.

1. Go to **Settings**.
2. Touch **About tablet**.
3. Scroll down to **Build number**.
4. Tap **Build number** seven times.  
The message **You are now a developer** displays.
5. Touch **Back**.
6. Touch **System > Developer options**.

### EMDK for Android

EMDK for Android provides developers with tools to create business applications for enterprise mobile devices. It is designed for use with Google's Android Studio and includes Android class libraries such as Barcode, sample applications with source code, and the associated documentation.

EMDK for Android allows applications to take full advantage of the capabilities that Zebra devices have to offer. It embeds Profile Manager technology within Android Studio IDE, providing a GUI-based development tool designed specifically for Zebra devices. This allows fewer lines of code, resulting in reduced development time, effort, and errors.

For more information, go to [techdocs.zebra.com/emdk-for-android/about/](https://techdocs.zebra.com/emdk-for-android/about/).

### StageNow for Android

StageNow is Zebra's next-generation Android Staging Solution built on the MX platform. It allows quick and easy creation of device profiles and can deploy to devices simply by scanning a barcode or reading a tag.

The StageNow Staging Solution includes the following components:

- The StageNow Workstation tool installs on the staging workstation (host computer) and lets the administrator easily create staging profiles for configuring device components, and perform other staging actions such as checking the condition of a target device to determine suitability for software upgrades or other activities. The StageNow Workstation stores profiles and other created content for later use.
- The StageNow Client resides on the device and provides a user interface for the staging operator to initiate staging. The operator uses one or more of the desired staging methods (print and scan a barcode or read an NFC tag) to deliver staging material to the device.

For more information, go to [techdocs.zebra.com/stagenow/](https://techdocs.zebra.com/stagenow/).

### GMS Restricted

GMS Restricted mode deactivates Google Mobile Services (GMS). All GMS apps are disabled on the device and communication with Google (analytics data collection and location services) is disabled.

Use StageNow to disable or enable GMS Restricted mode. After a device is in GMS Restricted mode, enable and disable individual GMS apps and services using StageNow. To ensure GMS Restricted mode persists after an Enterprise Reset, use the Persist Manager option in StageNow.

For more information, go to [techdocs.zebra.com/gmsmgr/](https://techdocs.zebra.com/gmsmgr/).

### ADB USB Setup

To use the Android Debug Bridge (ADB), install the development SDK on the host computer then install the ADB and USB drivers.

Before installing the USB driver, make sure that the development SDK is installed on the host computer. Go to [developer.android.com/sdk/index.html](https://developer.android.com/sdk/index.html) for details on setting up the development SDK.

The ADB and USB drivers for Windows and Linux are available on the Zebra Support Central website at [zebra.com/support](https://zebra.com/support). Download the ADB and USB Driver Setup package. Follow the instructions with the package to install the ADB and USB drivers for Windows and Linux.

#### Enabling USB Debugging

By default, USB debugging is disabled.

1. Go to **Settings**.
2. Touch **About tablet**.
3. Scroll down to **Build number**.
4. Tap **Build number** seven times.

The message **You are now a developer!** displays.

5. Touch **Back**.
6. Touch **System > Developer options**.
7. Slide the **USB debugging** switch to the **ON** position.
8. Touch **OK**.
9. Connect the device to the host computer using the Rugged Charge/USB Cable.  
The **Allow USB debugging?** dialog box displays on the device.  
If the device and host computer are connected for the first time, the **Allow USB debugging?** dialog box with the **Always allow from this computer** check box displays. Select the check box, if required.
10. Touch **OK**.
11. Touch **OK** or **Allow**.
12. On the host computer, navigate to the **platform-tools** folder and open a command prompt window.
13. Type `adb devices`.  
The following displays:

```
List of devices attached          XXXXXXXXXXXXXXXXXX device
```

Where XXXXXXXXXXXXXXXXXX is the device number.



**NOTE:** If device number does not display, ensure that ADB drivers are installed properly.

14. Return to the Home screen.

### Entering Android Recovery Manually

Many of the update methods discussed in this section require putting the device into Android Recovery mode. If you are unable to enter Android Recovery mode through `adb` commands, use the following steps to manually enter Android Recovery mode.

1. Press and hold the **Power** button until the menu displays.
2. Touch **Restart**.
3. Press and hold the **Volume Up** and **Power** button until the Zebra logo displays.
4. Release the **Power** button, but continue to hold the **Volume Up** until the System Recovery Screen displays.

## Application Installation

After an application is developed, install the application onto the device using one of the supported methods.

- Android Debug Bridge
- Wireless Android Debug Bridge
- USB connection
- USB drive

- Mobile device management (MDM) platforms that have application provisioning. Refer to the MDM software documentation for details.

### Installing Applications Using the USB Connection

Use the USB connection to install applications onto the device.

1. Connect the device to a host computer using the USB-C cable.  
When transferring files or debugging, ensure only one USB connection to the device exists. For example, do not dock the device or attach an expansion back if using a USB cable.
2. On the device, pull down the Notification panel and touch **Charging this device via USB**.  
By default, **No data transfer** is selected.
3. Touch **File Transfer**.
4. On the host computer, open a file explorer application.
5. On the host computer, copy the application APK file from the host computer to the device.



**CAUTION—PRODUCT DAMAGE:** Carefully follow the host computer's instructions to unmount the device and disconnect USB devices correctly to avoid losing information.

6. Disconnect the device from the host computer.
7. Swipe the screen up and select  to view files on the Internal Storage.
8. Locate the application APK file.
9. Touch the application file.
10. Touch **Continue** to install the app or **Cancel** to stop the installation.
11. To confirm installation and accept what the application affects, touch **Install**. Otherwise, touch **Cancel**.
12. Touch **Open** to open the application or **Done** to exit the installation process.

The application displays in the App list.

### Installing Applications Using the Android Debug Bridge

Use ADB commands to install applications onto the device.

1. Ensure that the ADB drivers are installed on the host computer.
2. Connect the device to a host computer using the USB-C cable.  
When transferring files or debugging, ensure only one USB connection to the device exists. For example, do not dock the device or attach an expansion back if using a USB cable.
3. Go to **Settings**.
4. Touch **System > Developer options**.
5. Slide the **USB debugging** switch to the **ON** position.
6. Touch **OK**.
7. If the device and host computer are connected for the first time, the **Allow USB debugging?** dialog box with the **Always allow from this computer** check box displays. Select the check box, if required.
8. Touch **OK** or **Allow**.

9. On the host computer, navigate to the **platform-tools** folder and open a command prompt window.
10. Type `adb install <application>`.  
where: `<application>` = the path and filename of the apk file.
11. Disconnect the USB-C cable from the device.

## Installing Applications Using the Wireless Android Debug Bridge

Use ADB commands to install an application onto the device.



**IMPORTANT:** Ensure the latest adb files are installed on the host computer.



**NOTE:** If the device number does not appear, ensure that ADB drivers are installed properly.

1. Go to **Settings**.
2. Touch **System > Developer options**.
3. Slide the **USB debugging** switch to the **ON** position.
4. Slide the **Wireless debugging** switch to the **ON** position.
5. If the device and host computer are connected for the first time, the **Allow wireless debugging on this network?** dialog box with the **Always allow from this network** check box displays. Select the check box, if required.
6. Touch **ALLOW**.
7. Touch **Wireless debugging**.
8. Touch **Pair with pairing code**.

The **Pair with device** dialog box displays.

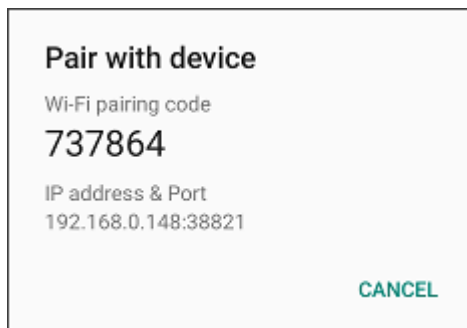

9. On the host computer, navigate to the **platform-tools** folder and open a command prompt window.
10. Type `adb pair XX.XX.XX.XX.XXXXX`.  
where `XX.XX.XX.XX.XXXXX` is the IP address and port number from the **Pair with device** dialog box.
11. Press **Enter**.
12. Type the pairing code from the **Pair with device** dialog box.
13. Press **Enter**.
14. Type `adb connect XX.XX.XX.XX:XXXXX`.  
where `XX.XX.XX.XX:XXXXX` is the IP address and port number from the **Pair with device** dialog box.

15. Press **Enter**.

The device is now connected to the host computer.

16. Type `adb devices`.

The following displays:

```
List of devices attached          XXXXXXXXXXXXXXXXXXXX device
```

Where XXXXXXXXXXXXXXXXXXXX is the device number.



**NOTE:** If device number does not appear, ensure that ADB drivers are installed properly.

17. On the host computer command prompt window type:

```
adb install <application>
```

18. On the host computer, type:

```
adb disconnect.
```

### Installing Applications Using a USB Drive

Use a USB drive to install applications on the device.



**NOTE:** A USB-A to USB-C converter is required only if your USB drive uses a Type A connector. Use the USB-A to USB-C converter and plug the USB drive into the USB port on the device.



**IMPORTANT:** USB Drive must have FAT32 format.

1. Plug the USB drive into the USB port on the host computer.
2. On the host computer, open a file explorer application.
3. Copy the application APK file from the host computer to the USB drive.



**CAUTION:** Follow the host computer's instructions to eject the USB drive correctly to avoid losing information.

4. Eject the USB drive from the host computer.
5. Using the USB-A to USB-C adapter, plug the USB drive into the USB port on the device. A notification appears indicating that the device detected the USB drive.
6. Swipe the screen up and select  to view files on the USB drive.
7. Touch **USB drive**.
8. Locate the application APK file.
9. Touch the application file.
10. Touch **Continue** to install the app or **Cancel** to stop the installation.
11. To confirm installation and accept what the application affects, touch **Install** otherwise touch **Cancel**.
12. Touch **Open** to open the application or **Done** to exit the installation process.

The application appears in the App list.

13. Disconnect the USB drive from the host computer.

### Uninstalling an Application

Free up device memory by removing unused apps.

1. Go to **Settings**.
2. Touch **Apps**.
3. Touch **See all apps** to view all apps in the list.
4. Scroll through the list to the app.
5. Touch the app.

The **App info** screen displays.

6. Touch **Uninstall**.
7. Touch **OK** to confirm.

### Android System Update

System Update packages can contain either partial or complete updates for the operating system. Zebra distributes the System Update packages on the Zebra Support & Downloads website. Perform a system update using ADB.

### Performing a System Update Using ADB

Use ADB to perform a system update.

1. Connect the device to a host computer using a USB-C cable.  
When transferring files or debugging, ensure only one USB connection to the device exists. For example, do not dock the device or attach an expansion back if using a USB cable.
2. Go to **Settings**.
3. Touch **System > Developer options**.
4. Slide the **USB debugging** switch to the **ON** position.
5. If the device and host computer are connected for the first time, the **Allow USB debugging?** dialog box with the **Always allow from this computer** check box displays. Select the check box, if required
6. Touch **OK**.
7. On the host computer, navigate to the **platform-tools** folder and open a command prompt window.
8. Type `adb devices`.  
If the device number does not display, ensure the ADB drivers are installed properly
9. Type `adb reboot recovery`.
10. Press **Enter**.  
The System Recovery screen displays on the device.
11. Press **Volume Up** and **Volume Down** to navigate to **Apply upgrade from ADB**

12. Press **Power**.
13. On the host computer command prompt window type `adb sideload <file>`.  
where: <file> = the path and filename of the zip file
14. Press **Enter**.  
The System Update installs (progress displays as a percentage in the Command Prompt window), and then the System Recovery screen displays on the device.
15. Press **Power** to reboot the device.

### Performing a System Update Using a USB Drive

Use a USB drive to perform a system update.

1. Connect the device to a host computer using a USB-C cable or by inserting the device into the 1-Slot USB/Ethernet Cradle.
2. Go to **Settings**.
3. Touch **System > Developer options**.
4. Slide the **USB debugging** switch to the **ON** position.
5. If the device and host computer are connected for the first time, the **Allow USB debugging?** dialog box with the **Always allow from this computer** check box displays. Select the check box, if required.
6. Touch **OK**.
7. On the host computer, navigate to the **platform-tools** folder and open a command prompt window.
8. Type `adb devices`.  
If the device number does not display, ensure the ADB drivers are installed properly.
9. Type `adb reboot recovery`.
10. Press **Enter**.  
The System Recovery screen displays on the device.
11. Press **Volume Up** and **Volume Down** to navigate to **Apply upgrade from ADB**.
12. Press **Power**.
13. On the host computer command prompt window, type `adb sideload <file>`.  
where: <file> = the path and filename of the zip file.
14. Press **Enter**.  
The System Update installs (progress displays as a percentage in the Command Prompt window), and then the System Recovery screen displays on the device.
15. Press **Power** to reboot the device.

### Performing a System Update Using a microSD Card

Use a microSD card to perform a system update.

1. Connect the device to a host computer using a USB-C cable.  
When transferring files or debugging, ensure only one USB connection to the device exists. For example, do not dock the device or attach an expansion back if using a USB cable.

2. Go to **Settings**.
3. Touch **System > Developer options**.
4. Slide the **USB debugging** switch to the **ON** position.  
If the device and host computer are connected for the first time, the **Allow USB debugging?** dialog box with the **Always allow from this computer** check box displays. Select the check box, if required.
5. Touch **OK**.
6. On the host computer, navigate to the `platform-tools` folder and open a command prompt window.
7. Type `adb devices`.  
If the device number does not display, ensure the ADB drivers are installed properly.
8. Type `adb reboot recovery`.
9. Press **Enter**.  
The System Recovery screen displays on the device.
10. Press **Volume Up** and **Volume Down** to navigate to **Apply upgrade from ADB**.
11. Press **Power**.
12. On the host computer command prompt window type `adb sideload <file>`.  
Where: `<file>` = the path and filename of the zip file.
13. Press **Enter**.  
The System Update installs (progress displays as a percentage in the Command Prompt window), and then the System Recovery screen displays on the device.
14. Press **Power** to reboot the device.

### Verifying System Update Installation

Verify that the system update was successful.

1. Go to **Settings**.
2. Touch **About tablet**.
3. Scroll down to **Build number**.
4. Ensure that the build number matches the new system update package file number.

### Android Enterprise Reset

An Enterprise Reset erases all user data in the `/data` partition, including data in the primary storage locations (emulated storage), while preserving the contents of the `/enterprise` folder and its subfolders. Zebra distributes the Enterprise Reset packages on the Zebra Support & Downloads website.

Before performing an Enterprise Reset, provision all necessary configuration files and restore after the reset.

### Performing an Enterprise Reset Using ADB

Perform an Enterprise Reset using ADB.

Go to the Zebra Support & Downloads web site at [zebra.com/support](https://zebra.com/support) and download the appropriate Enterprise Reset file to a host computer.

1. Connect the device to a host computer using a USB-C cable.  
When transferring files or debugging, ensure only one USB connection to the device exists. For example, do not dock the device or attach an expansion back if using a USB cable.
2. Go to **Settings**.
3. Touch **System > Developer options**.
4. Use **Volume Up** and **Volume Down** to navigate to **Enterprise Reset Package**.
5. If the device and host computer are connected for the first time, the **Allow USB debugging?** dialog box with the **Always allow from this computer** check box displays. Select the check box, if required.
6. Touch **OK** or **Allow**.
7. Touch **OK**.
8. Press **Scan** to reboot the device.
9. Use **Volume Up** and **Volume Down** to navigate to **Enterprise Reset Package**.
10. Press **Power**.

### Performing an Enterprise Reset Using USB Drive

Perform an Enterprise Reset using a USB drive.

Go to the Zebra Support & Downloads web site at [zebra.com/support](https://zebra.com/support) and download the appropriate Enterprise Reset file to a host computer.

1. Copy the Enterprise Reset zip file to the root of the USB drive and then install the USB drive into the device.
2. Press and hold **Power** until the menu appears.
3. Touch **Restart**.
4. Press and hold the **Volume Up** and **Power** button until the Zebra boot screen appears.  
The Android Recovery screen appears.
5. Press **Up** and **Down** to navigate to the **apply update from USB drive**.
6. Press **Power**.
7. Press **Up** and **Down** to navigate to the Enterprise Reset file.
8. Press **Power**.  
The Enterprise Reset occurs, and then the device returns to the Recovery screen.
9. Press **Power**.

## Performing an Enterprise Reset Using a microSD Card

It is strongly recommended that, prior to use, you format the microSD card on the device.

1. Copy the Enterprise Reset zip file to the root of the microSD card.
  - Copy the zip file to a microSD card using a host computer and then install the microSD card into the device.
  - Connect the device with a microSD card already installed to the host computer and copy the zip file to the microSD card.
2. Disconnect the device from the host computer.
3. Press and hold **Power** until the menu appears.
4. Touch **Restart**.
5. Press and hold **PTT** until the device vibrates.  
The System Recovery screen appears.
6. Press **Volume Up** and **Volume Down** to navigate to **Apply upgrade from SD card**.
7. Press **Power**.
8. Press **Volume Up** and **Volume Down** to navigate to the Enterprise Reset file.
9. Press **Power**.  
The Enterprise Reset occurs and then the device returns to the Recovery screen.
10. Press **Power** to reboot the device.

## Performing an Enterprise Reset From Device Settings

Perform an Enterprise Reset from the device settings.

1. Go to **Settings**.
2. Touch **System > Reset Options > Erase all data (factory reset)**.
3. Touch **Erase all data** twice to confirm the Enterprise Reset.

## Android Factory Reset

A Factory Reset erases all data in the /data and /enterprise partitions in internal storage and clears all device settings. A Factory Reset returns the device to the last installed operating system image. To revert to a previous operating system version, re-install that operating system image. Zebra distributes the Factory Reset packages on the Zebra Support & Downloads website.

## Performing a Factory Reset Using ADB

Initiate a Factory Reset on the using ADB.

Go to the Zebra Support & Downloads web site at [zebra.com/support](http://zebra.com/support) and download the appropriate Factory Reset file to a host computer.

1. Connect the device to your host computer with a USB cable.
2. Open a command prompt or terminal on your host computer.

3. Verify your device's ADB connection by running the following command:

```
adb devices
```

If the command lists your device as "unauthorized," check the device's screen. You must accept the RSA key fingerprint prompt to authorize the connection.

4. Reboot the device into its recovery mode by executing this command:

```
adb reboot recovery
```

The device restarts and displays the Android Recovery menu.

5. Use **Volume Up** or **Volume Down** to navigate the recovery menu.

You cannot use ADB to control the device while it is in recovery mode.

6. Navigate to and highlight the **Wipe data/factory reset** option.

7. Press the device's **Power** button to select the option.

8. Navigate to and select **Factory data reset** to confirm your choice.

The device begins the factory reset process. This may take several minutes to complete.

9. After the device completes the data wipe, the recovery menu reappears. Tap the **Reboot system now** option.

The device reboots and starts the initial setup wizard. You have successfully performed a factory reset.

### Performing a Factory Reset Using a USB Drive

Initiate a Factory Reset on the device using a USB drive.

Go to the Zebra Support & Downloads web site at [zebra.com/support](http://zebra.com/support) and download the appropriate Factory Reset file to a host computer.

1. Copy the Factory Reset zip file to the root of the USB drive using a host computer and then install the USB drive into the device.

2. Press and hold **Power** until the menu appears.

3. Touch **Restart**.

The device resets.

4. Press and hold the **Volume Up** and **Power** button until the Zebra boot screen.

The System Recovery screen appears.

5. Press **Up** and **Down** to navigate to the **apply update from USB drive**.

6. Press **Power**.

7. Press **Up** and **Down** to navigate to the Android Reset file.

8. Press **Power**.

The Factory Reset occurs and then the device returns to the Recovery screen.

9. Press **Power**.

### Performing a Factory Reset Using a microSD card

Initiate a Factory Reset on the device using a microSD card.

Go to the Zebra Support & Downloads web site at [zebra.com/support](https://zebra.com/support) and download the appropriate Factory Reset file to a host computer.

1. Copy the Factory Reset zip file to the root of the microSD card.
  - Copy the zip file to a microSD card using a host computer and then install the microSD card into the device.
  - Connect the device with a microSD card already installed to the host computer, copy the zip file to the microSD card, and then disconnect the device from the host computer.
2. Press and hold **Power** until the menu appears.
3. Touch **Restart**.
4. Press and hold the **Volume Up** and **Power** button until the device vibrates.  
The System Recovery screen appears.
5. Press **Volume Up** and **Volume Down** to navigate to **Apply upgrade from SD card**.
6. Press **Power**.
7. Use **Volume Up** and **Volume Down** to navigate to the Factory Reset file.
8. Press **Power**.  
The Factory Reset occurs, and then the device returns to the Recovery screen.
9. Press **Power** to reboot the device.

### Android Storage

The device contains multiple types of file storage.

- Random Access Memory (RAM)
- On-device Storage

### Random Access Memory

Executing programs use RAM to store data. Data stored in RAM is lost upon a reset.

The operating system manages how applications use RAM. It only allows applications and component processes and services to use RAM when required. It may cache recently used processes in RAM, so they restart more quickly when opened again, but it will erase the cache if it needs the RAM for new activities.

The screen displays the amount of used and free RAM.

- **Performance** - Indicates memory performance.
- **Total memory** - Indicates the total amount of RAM available.
- **Average used (%)** - Indicates the average amount of memory (as a percentage) used during the period of time selected (default - 3 hours).
- **Free** - Indicates the total amount of unused RAM.
- **Memory used by apps** - Touch to view RAM usage by individual apps.

## Viewing Memory

View the amount of memory used and free RAM.

Complete [Enabling Developer Options](#) before you continue:

1. Go to **Settings**.
2. Touch **System > Developer options**.
3. Touch **Memory**.

## Internal Storage

The device has internal storage. The internal storage content can be viewed and files copied to and from when the device is connected to a host computer. Some applications are designed to be stored on the internal storage rather than in internal memory.

### Viewing Internal Storage

View available and used internal storage on the device.

1. Go to **Settings**.
2. Touch **Storage**.

**Storage** displays the total amount of space on internal storage and the amount used.

If the device has removable storage installed, touch **Internal shared storage** to display the amount of internal storage used by apps, photos, videos, audio, and other files.

## External Storage

The device supports both a removable USB drive and a microSD card. The content of these storage options can be viewed, and files can be copied to and from them when the device is connected to a host computer.

### Viewing External Storage

Portable storage displays the total amount of space on the installed USB drive or microSD card and the amount used.

1. Go to **Settings**.
2. Touch **Storage**.  
Touch **USB Drive** or **microSD card** to view the contents.
3. To unmount the USB drive or microSD card, touch .

### Formatting a USB Drive as Portable Storage

Format a USB drive as portable storage on the device.

1. Touch **USB drive**.
2. Touch  > **Storage settings**.
3. Touch **Format**.

4. Touch **FORMAT USB DRIVE**.
5. Touch **DONE**.

### Formatting a MicroSD Card as Portable Storage

Format a MicroSD Card as portable storage on the device.

1. Touch **MicroSD Card**.
2. Touch  **Storage settings**.
3. Touch **Format**.
4. Touch **FORMAT MicroSD Card**.
5. Touch **DONE**.

### Enterprise Folder

The Enterprise folder (within internal flash) is a super-persistent storage that is persistent after a reset and an Enterprise Reset.

The Enterprise folder is erased during a Factory Reset. The Enterprise folder is used for deployment and device-unique data. The Enterprise folder is approximately 512 MB (formatted). Applications can persist data after an Enterprise Reset by saving data to the enterprise/user folder. The folder is ext4 formatted and is only accessible from a host computer using ADB or from an MDM.

### Managing Apps

Apps use two kinds of memory: storage memory and RAM. Apps use storage memory for themselves and any files, settings, and other data they use. They also use RAM when they are running.

1. Go to **Settings**.
2. Touch **Apps**.
3. Touch **See all apps** to view all apps on the device.
4. Touch  **> Show system** to include system processes in the list.
5. Touch an app, process, or service in the list to open a screen with details about it and, depending on the item, to change its settings, permissions, notifications and to force stop or uninstall it.

### App Details



Apps have different kinds of information and controls.

- **Force stop** - Stop an app.
- **Disable** - Disable an app.
- **Uninstall** - Remove the app and all of its data and settings from the device.
- **Notifications** - Set the app notification settings.
- **Permissions** - Lists the areas on the device that the app has access to.
- **Storage & cache** - Lists how much information is stored and includes buttons for clearing it.
- **Wi-Fi data usage** - Provides information about data consumed by an app.

- **Screen time** - Displays the amount of time the app has displayed on the screen.
- **App battery usage** - Lists the amount of computing power used by the app.
- **Open by default** - If you have configured an app to launch certain file types by default, you can clear that setting here.
- **Language** - Set the language preferences for the app.
- **Unused app settings**
  - **Manage app if unused** - Manage settings or actions for apps that have not been used for a specified period.
- **Advanced**
  - **Picture-in-picture** - Enable or disable the app's ability to display in a floating window over other apps.
  - **Install unknown apps** - Allow or prevent the installation of apps from unknown sources.

## Managing Downloads

Files and apps downloaded using the Browser or Email are stored on the USB drive or Internal storage in the Download directory. Use the Downloads app to view, open, or delete downloaded items.

1. Swipe the screen up and touch .
2. Touch **Downloads**.
3. Touch and hold an item to delete, and then touch .

The item is deleted from the device.

# Maintenance and Troubleshooting

This section explains how to maintain and troubleshoot the device and accessories.

## Maintaining the Device

Follow these guidelines to maintain the device properly.

- To avoid scratching the screen, use a Zebra-approved, capacitive-compatible stylus intended for use with a touch-sensitive screen. Never use an actual pen, pencil, or other sharp object on the surface of the device screen.
- The device's touch-sensitive screen is made of glass. Do not drop the device or subject it to strong impact.
- Protect the device from temperature extremes. Do not leave it on the dashboard of a car on a hot day, and keep it away from heat sources.
- Do not store the device in any dusty, damp, or wet location.
- Use a soft lens cloth to clean the device. If the surface of the device screen becomes soiled, clean it with a soft cloth moistened with an approved cleanser.
- Periodically replace the rechargeable battery to ensure maximum battery life and product performance. Battery life depends on individual usage patterns.

## Battery Safety Guidelines

To use the device safely, you must follow the battery guidelines.

- The area in which the units are charged should be clear of debris and combustible materials or chemicals. Particular care should be taken when the device is charged in a non-commercial environment.
- Follow the battery usage, storage, and charging guidelines found in this guide.
- Improper battery use may result in a fire, explosion, or other hazard.
- To charge the mobile device battery, the battery and charger temperatures must be between +5°C and +40°C (41°F and 104°F).
- Do not use incompatible batteries and chargers, including non-Zebra batteries and chargers. Use of an incompatible battery or charger may present a risk of fire, explosion, leakage, or other hazard. If you have any questions about the compatibility of a battery or a charger, contact the Global Customer Support Center.

- For devices that utilize a USB port as a charging source, the device shall only be connected to products that bear the USB-IF logo or have completed the USB-IF compliance program.
- Do not disassemble, open, crush, bend, deform, puncture, or shred the battery.
- Severe impact from dropping any battery-operated device on a hard surface could cause the battery to overheat.
- Do not short-circuit a battery or allow metallic or conductive objects to contact the battery terminals.
- Do not modify or remanufacture, attempt to insert foreign objects into the battery, immerse or expose to water or other liquids, or expose to fire, explosion, or other hazard.
- Do not leave or store the equipment in or near areas that might get very hot, such as in a parked vehicle or near a radiator or other heat source. Do not place a battery into a microwave oven or dryer.
- Battery usage by children should be supervised.
- Please follow local regulations to properly dispose of used rechargeable batteries.
- Do not dispose of batteries in a fire.
- In the event of a battery leak, do not allow the liquid to come in contact with the skin or eyes. If contact has been made, wash the affected area with water for 15 minutes, and seek medical advice.
- If you suspect damage to your equipment or battery, contact Customer Support to arrange for inspection.

### **Best Practices for Enterprise Mobile Devices Operating in Hot Environments and Direct Sunlight**

Exceeding the operating temperature by external hot environments will cause the device's thermal sensor to notify the user of a shut down the device until the device's temperature returns to the operational temperature range.

- Avoid direct sunlight to the device - The easiest way to prevent overheating is to keep the device out of direct sunlight. The device absorbs sunlight and heat and retains them, getting hotter the longer it remains in sunlight and heat.
- Avoid leaving the device in a vehicle on a hot day or hot surface - Similar to leaving the device out in direct sunlight, the device will also absorb the thermal energy from a hot surface or when left on the dashboard of a vehicle or seat, getting warmer the longer it remains on the hot surface or inside the hot vehicle.
- Turn off unused apps on the device. Open, unused apps running in the background can make the device to work harder, which may cause it to heat up. This will also improve your mobile device's battery life.
- Avoid turning your screen brightness up - Just the same as running background apps, turning your brightness up will force your battery to work harder and create more heat. Minimizing your screen brightness may extend the time you can use the mobile computer device in hot environments.

### **Properly Plugging and Unplugging a USB-C Cable**

This section outlines the proper procedures for safely connecting and disconnecting a USB Type-C cable to prevent damage to the device's connector port.

When connecting/disconnecting the cable from your device:

- Visually inspect the input connector for damage, foreign materials, or signs of moisture.

- Avoid inserting or removing the cable in a non-horizontal direction (for example, upward, downward, left, right, or forward direction). Keep it straight.

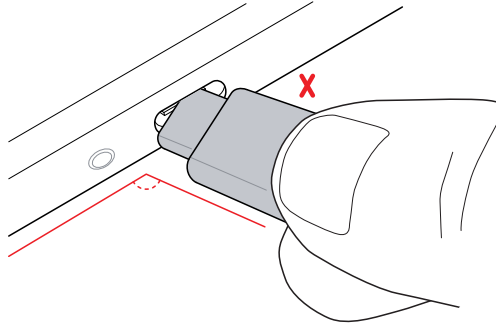

- Avoid inserting or removing the cable in a forceful manner.
- Avoid wiggling the cable when plugged into the port.
- Avoid pulling or tugging the cable when plugged into the port.

### Cleaning Instructions

This section provides instructions for cleaning the device.

Use caution and avoid damaging the device when using cleaning materials.



**CAUTION:** Always wear eye protection. Read the warning label on alcohol product before using. If you have to use any other solution for medical reasons please contact the Global Customer Support Center for more information.



**WARNING:** Avoid exposing this product to contact with hot oil or other flammable liquids. If such exposure occurs, unplug the device and clean the product immediately in accordance with these guidelines.

### Approved Cleanser Active Ingredients

100% of the active ingredients in any cleaner must consist of one or some combination of the following: isopropyl alcohol or mild dish soap.



**IMPORTANT:** Use pre-moistened wipes and do not allow liquid cleaner to pool.

Approved cleaners include:

- Purell Ethanol Wipes
- 409 Glass Cleaner
- Windex Blue

### Harmful Ingredients

The following chemicals are known to damage the plastics on the device and should not come in contact with the device: acetone; ketones; ethers; aromatic and chlorinated hydrocarbons; aqueous or alcoholic alkaline solutions; ethanolamine; toluene; trichloroethylene; benzene; carbolic acid and TB-lysoform.

Many vinyl gloves contain phthalate additives, which are often not recommended for medical use and are known to be harmful to the housing of the device.

### Special Cleaning Notes

This section describes essential handling precautions.

Do not handle the device while wearing vinyl gloves containing phthalates. Remove vinyl gloves and wash hands to eliminate any residue left from the gloves.

If products containing any of the harmful ingredients listed above are used prior to handling the device, such as a hand sanitizer that contains ethanolamine, hands must be completely dry before handling the device to prevent damage to the device.



**IMPORTANT:** If the battery connectors are exposed to cleaning agents, thoroughly wipe off as much of the chemical as possible and clean with an alcohol wipe. It is also recommended to install the battery in the terminal prior to cleaning and disinfecting the device to help minimize buildup on the connectors. When using cleaning/disinfectant agents on the device, it is important to follow the directions prescribed by the cleaning/disinfectant agent manufacturer.

### Cleaning Frequency

The cleaning frequency is at the customer's discretion due to the varied environments in which the mobile devices are used and may be cleaned as frequently as required. When dirt is visible, it is recommended to clean the mobile device to avoid the build-up of particles, which makes the device more difficult to clean later on.

### Device Cleaning Instructions

Do not apply liquid directly to the device. Dampen a soft cloth or use pre-moistened wipes. Do not wrap the device in the cloth or wipe, instead gently wipe the unit. Before use, allow the unit to air dry.



**NOTE:** For thorough cleaning, it is recommended to first remove all accessory attachments, such as hand straps or cradle cups from the mobile device and to clean them separately.

### Display

The display can be wiped down with an approved alcohol wipe, but care should be taken not to allow any pooling of liquid around the edges of the display. Immediately dry the display with a soft, non-abrasive cloth to prevent streaking.

### Housing

Thoroughly wipe the housing, including all buttons and triggers, using an approved alcohol wipe.

### Camera and Exit Window

Wipe the camera and exit the window periodically with lens tissue or other material suitable for cleaning optical material such as eyeglasses.

### Cleaning Cradle Connectors

This section provides instructions on how to clean the cradle connectors.

1. Remove the DC power cable from the cradle.
2. Dip the cotton portion of the cotton-tipped applicator in isopropyl alcohol.
3. Rub the cotton portion of the cotton-tipped applicator along the pins of the connector. Slowly move the applicator back and forth from one side of the connector to the other. Do not leave any cotton residue on the connector.
4. All sides of the connector should also be rubbed with the cotton-tipped applicator.
5. Remove any lint left by the cotton-tipped applicator.
6. If grease and other dirt can be found on other areas of the cradle, use a lint-free cloth and alcohol to remove.
7. Allow at least 10 to 30 minutes (depending on ambient temperature and humidity) for the alcohol to air dry before applying power to cradle.

If the temperature is low and humidity is high, longer drying time is required. Warm temperature and low humidity requires less drying time.



**CAUTION:** After cleaning the cradle connectors with bleach-based chemicals, follow the Cleaning Cradle Connectors instructions to remove bleach from the connectors.

### Cleaning the Speaker Area

This section explains how to clean the device speaker area to ensure optimal sound quality and performance.



**NOTE:** Use a soft, clean, small dedicated device cleaning brush, a soft-bristled watercolor paintbrush, a clean makeup brush, or a dry soft-bristled toothbrush.

1. Power off the device to prevent damage during cleaning.
2. Gently brush the surface of the speaker area at an angle. Use light strokes to avoid damaging the speaker mesh.
3. Always brush in one consistent direction (for example, top to bottom or side to side) to avoid pushing the dust into the speaker area.

After brushing, use one of the following tools to remove the loosened dust:

- A handheld vacuum set to a low suction setting.
- A hairdryer set to a cool setting and held at a safe distance from the device.

## Shelf Mode

Devices left in storage for extended periods should be put in Shelf Mode to preserve the battery and prevent it from depleting. A device in shelf mode maintains a functional battery level for up to a year.

This mode is particularly useful for devices stored for an extended period. The conditions for storing a device in Shelf Mode are:

- The device's battery level is between 60 - 80%.



**NOTE:** The recommended battery state of charge (SOC) is the optimal range to guarantee battery life in shelf mode at room temperature.

- The storage temperature is < 40°C (104°F).

## Using Shelf Mode

Enter and exit shelf mode using the StageNow app.

Minimum compatible MXMF version: 13.4.

1. Open the StageNow app.
2. Scan the barcode.

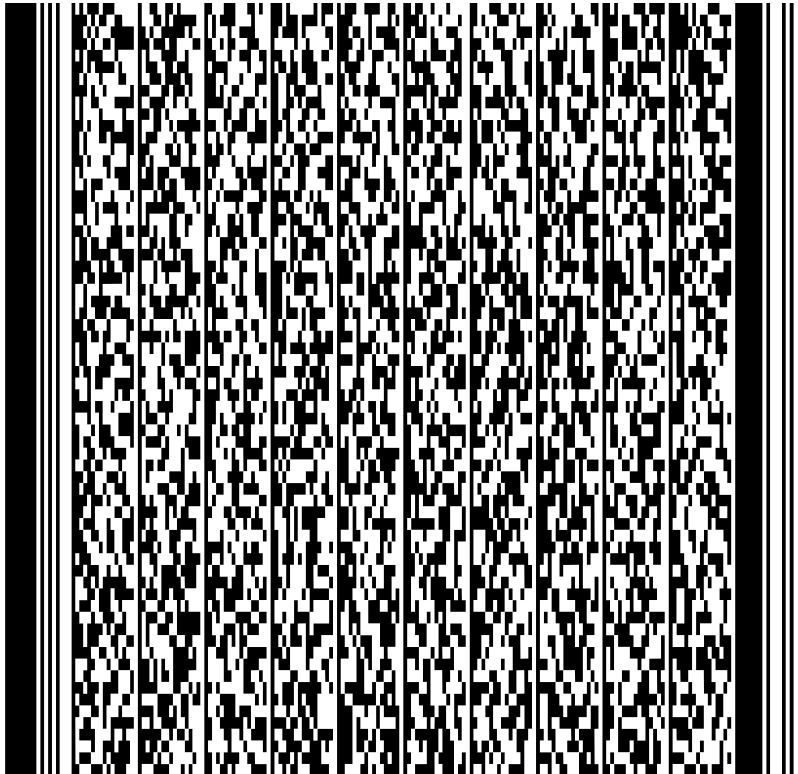

The device disables BLE beaconing and executes a graceful shutdown.



**NOTE:** To exit shelf mode, place the device on a charger or power it on.

## Troubleshooting

In rare circumstances, to troubleshoot the device, you may need to reset the device.

### Resetting the Device

There are two reset functions, soft reset and hard reset.

#### Performing a Soft Reset

Perform a soft reset if applications stop responding.

1. Press and hold Power until the menu appears.
2. Touch **Restart**.

The device reboots.

#### Performing a Hard Reset

Perform a hard reset if the device stops responding.

1. Press and hold the Power, Volume Up, and top Scan buttons.
2. When the screen turns off, release the buttons.

The device reboots.

## Device Troubleshooting

This section provides troubleshooting options for the device.

**Table 30** Troubleshooting the Device

| Problem  | Cause   | Solution   |
|--|---|--|
| After installing the battery, the device does not boot up.                     | Power button was not pressed.   | Press the Power button.  |
| When pressing the power button the device does not turn on.                    | Battery not charged.  | Charge or replace the battery in the device.                                 |
|  | Battery not installed properly.   | Install the battery properly.  |
|  | System crash.   | Perform a hard reset.  |
| When pressing the power button the device does not turn on but two LEDs blink. | Battery charge is at a level where data is maintained but battery should be re-charged. | Charge or replace the battery in the device.                                 |
| Battery did not charge.  | Battery failed.   | Replace battery. If the device still does not operate, perform a hard reset. |
|  | Device removed from cradle while battery was charging.                                  | Insert the device into the cradle and begin charging.                        |

**Table 30** Troubleshooting the Device (Continued)

| Problem  | Cause   | Solution  |
|--|---|---|
|  | Extreme battery temperature.  | The ambient temperature must be between 0°C and 40°C (32 °F and 104°F).   |
| Cannot see characters on display.  | Device not powered on.  | Press the Power button.   |
| During data communication with a host computer, no data transmitted, or transmitted data was incomplete. | Device removed from cradle or disconnected from host computer during communication. | Replace the device in the cradle, or reattach the communication cable and re-transmit.                                    |
|  | Incorrect cable configuration.  | See the system administrator.   |
|  | Communication software was incorrectly installed or configured.                     | Perform setup.  |
| During data communication over Wi-Fi, no data transmitted, or transmitted data was incomplete.           | Wi-Fi radio is not on.  | Turn on the Wi-Fi radio.  |
|  | You moved out of range of an access point.  | Move closer to an access point.   |
| During data communication over Bluetooth, no data transmitted, or transmitted data was incomplete.       | Bluetooth radio is not on.  | Turn on the Bluetooth radio.  |
|  | You moved out of range of another Bluetooth device.                                 | Move within 10 meters (32.8 feet) of the other device.  |
| During data communication over mobile data, no data transmitted, or transmitted data was incomplete.     | Mobile data is not on.  | Turn on mobile data. If it is already on, turn it off and on again.   |
|  | You moved out of the coverage area.   | Move into a coverage area.  |
| No sound.  | Volume setting is low or turned off.  | Adjust the volume.  |
| Device shuts off.  | Device is inactive.   | The display turns off after a period of inactivity. Set this period to 15 seconds, 30 seconds, 1, 2, 5, 10 or 30 minutes. |
|  | Battery is depleted.  | Replace the battery.  |
| The multi-touch screen responds slowly or improperly.  | Finger or screen is wet.  | Ensure that your hands are clean and dry when touching the screen. Restart the device to try again.                       |
| A message appears stating that the device memory is full.  | Too many files stored on the device.  | Delete unused files. If necessary, save the files on a host computer.   |
|  | Too many applications installed on the device.                                      | Remove user-installed applications on the device to recover memory.   |

**Table 30** Troubleshooting the Device (Continued)

| Problem  | Cause  | Solution   |
|--|--|--|
| The device does not decode with reading barcode.       | Scanning application is not loaded.                                      | Load a scanning application on the device or enable DataWedge. See the system administrator.   |
|  | Unreadable barcode.  | Ensure the symbol is not defaced.  |
|  | Distance between exit window and barcode is incorrect.                   | Place the device within proper scanning range.   |
|  | Device is not programmed for the barcode.                                | Program the device to accept the type of barcode being scanned. Refer to the EMDK or DataWedge application.  |
|  | Device is not programmed to generate a beep.                             | If the device does not beep on a good decode, set the application to generate a beep on good decode.   |
|  | Battery is low.  | If the scanner stops emitting a laser beam upon a trigger press, check the battery level. When the battery is low, the scanner shuts off before the device low battery condition notification. Note: If the scanner is still not reading symbols, contact the distributor or the Global Customer Support Center. |
| Device cannot find any Bluetooth devices nearby.       | Too far from other Bluetooth devices.                                    | Move closer to the other Bluetooth device(s), within a range of 10 meters (32.8 feet).   |
|  | The Bluetooth device(s) nearby are not turned on.                        | Turn on the Bluetooth device(s) to find.   |
|  | The Bluetooth device(s) are not in discoverable mode.                    | Set the Bluetooth device(s) to discoverable mode. If needed, refer to the device's user documentation for help.  |
| Cannot unlock device.                                  | User enters incorrect password.  | If you enter an incorrect password five times, you are requested to wait for 30 seconds when using a PIN, Pattern or Password.   |
| Multi-User mode is causing undefined behavior.         | Multi-User mode is not supported by the Mobility DNA Enterprise License. | Perform a soft or hard reset on the device.  |
| Cannot transfer files or debug using a USB connection. | Too many USB connections to the device.                                  | When connecting the device to a host computer, only one USB-C interface is allowed. For example, if using a USB-C cable, ensure the device is not in a cradle and does not have an expansion back attached.  |
| USB headset connection is disrupted.                   | Too many USB connections to the device.                                  | If you dock the device or attach an expansion back while using a USB headset, the headset connection is momentarily disrupted. The headset automatically reconnects within a few seconds. No action is required.   |

## 1-Slot PD Charging Cradle Troubleshooting

This section provides troubleshooting options for charge only cradles.

**Table 31** Troubleshooting the 1-Slot PD Charging Cradle

| Symptom                  | Possible Cause  | Solution  |
|--------------------------|---|---|
| Battery is not charging. | Device was removed from cradle or cradle was unplugged from AC power. | Ensure cradle is receiving power. Ensure device is seated correctly. Confirm main battery is charging. The battery fully charges in approximately four hours. |
|                          | Battery is faulty.  | Verify that other batteries charge properly. If so, replace the faulty battery.   |
|                          | The device is not fully seated in the cradle.                         | Remove and re-insert the device into the cradle, ensuring it is firmly seated.  |
|                          | Ambient temperature of the cradle is too warm or too cold.            | Move the cradle to an area where the ambient temperature is between 0°C and 40°C (32°F and 104°F).  |

## 4-Slot Cradle-Only Troubleshooting

The table below provides troubleshooting options for the cradle.

**Table 32** Troubleshooting the 4-Slot Cradle

| Problem                      | Cause   | Solution  |
|------------------------------|---|---|
| The battery is not charging. | The device was removed from the cradle too soon.    | Replace the device in the cradle. The battery charges fully in approximately four hours.                          |
|                              | The battery is faulty.                              | Verify that other batteries charge properly. If so, replace the faulty battery.                                   |
|                              | The device is not inserted correctly in the cradle. | Remove the device and reinsert it correctly. Check the charging indicator LED to confirm that charging is active. |
|                              | The ambient temperature of the cradle is too warm.  | Move the cradle to an area where the ambient temperature is between 0°C and 40°C (32°F and 104°F).                |

## 4-Slot PowerPack Charger Troubleshooting

This section provides troubleshooting options for the 4-Slot PowerPack Charger.

**Table 33** Troubleshooting the 4-Slot PowerPack Charger

| Symptom  | Possible Cause   | Solution   |
|--|--|--|
| PowerPack Charging LED does not light when inserted. | PowerPack is not correctly seated.   | Remove and re-insert the spare battery into the charging slot, ensuring it is correctly seated.  |
| PowerPack is not charging.                           | PowerPack was removed from charger or charger was unplugged from AC power. | Ensure charger is receiving power. Ensure PowerPack is seated correctly. Confirm PowerPack is charging. The PowerPack fully charges in approximately four hours. |
|  | PowerPack is faulty.   | Verify that other PowerPack charge properly. If so, replace the faulty PowerPack.  |
|  | The PowerPack is not fully seated in the charger.                          | Remove and re-insert the PowerPack into the charger, ensuring it is firmly seated.   |
|  | Ambient temperature of the charger is too warm or too cold.                | Move the charger to an area where the ambient temperature is between 0°C and 40°C (32°F and 104°F).  |

# Technical Specifications

For device technical specifications, go to [zebra.com/support](http://zebra.com/support).

## SE4100 Decode Distances

The following table lists the typical distances for selected barcode densities. The minimum element width (or “symbol density”) is the width in mils of the narrowest element (bar or space) in the symbol.

**Table 34** SE4100 Decode Distances

| Symbol Density/Barcode Type | Typical Working Ranges |                    |
|-----------------------------|------------------------|--------------------|
|                             | Near                   | Far                |
| 5 mil Code 39               | 6.1 cm (2.4 in.)       | 24.1 cm (9.5 in.)  |
| 5 mil Code 128              | 7.1 cm (2.8 in.)       | 22.9 cm (9.0 in.)  |
| 6.67 mil PDF417             | 6.1 cm (2.4 in.)       | 20.3 cm (8.0 in.)  |
| 10 mil Data Matrix          | 7.4 cm (2.9 in.)       | 22.9 cm (9.0 in.)  |
| 100% UPCA                   | 4.6* cm (1.8* in)      | 49.5 cm (19.5 in.) |
| 15 mil QR Code              | 3.05* cm (1.2* in)     | 30.5 cm (12.0 in.) |
| 20 mil QR Code              | 3.05* cm (1.2* in)     | 35.6 cm (14.0 in.) |
| 20 mil Code 39              | 5.08* cm (2.0* in)     | 66.0 cm (26.0 in.) |

\*Limited by the width of the barcode in the field of view.



**NOTE:** Photographic quality barcode at 18° tilt pitch angle under 30 fcd ambient illumination. UPC, 20mil code 39, 15mil QR, and 20mil QR near distances correspond to the barcode located in the overlapping region of illumination and imaging fields of view.

## SR500 Decode Distances

The following table provides the decode distances for the SR500 scan engine.

**Table 35** SR500 Typical Decode Ranges

| Barcode Type   | Near Distance (cm / in) | Far Distance (cm / in) |
|--|-------------------------|------------------------|
| 3 mil Code 39  | 6.1 cm (2.4 in)         | 17.3 cm (6.8 in)       |
| 5 mil Code 128   | 4.8 cm (1.9 in)         | 10.1 cm (25.7 in)      |
| 5 mil Code 39  | 4.4 cm (1.7 in)         | 28.6 cm (11.3 in)      |
| 5 mil PDF417   | 7.1 cm (2.8 in)         | 20.3 cm (8.0 in)       |
| 6.67 mil PDF417  | 5.6 cm (2.2 in)         | 26.2 cm (10.3 in)      |
| 10 mil Data Matrix   | 4.6 cm (1.8 in)         | 31.5 cm (12.4 in)      |
| 100% UPCA  | 3.8 cm (1.5 in)         | 65.3 cm (25.7 in)      |
| 15 mil Code 128  | 6.4 cm (2.5 in)         | 74.2 cm (29.2 in)      |
| 20.0 mil Code 39   | 5.1 cm (2.0 in)         | 102.6 cm (40.4 in)     |
| 20.0 mil QR Code   | 5.3 cm (2.1 in)         | 49.3 cm (19.4 in)      |
| Note: Decode performance is dependent on print quality, including resolution, contrast, and ambient lighting conditions. |                         |                        |

## 1-Slot PD Charging Cradle Specifications

This section provides specification information on the 1-Slot PD Charging Cradle.

**Table 36** 1-Slot PD Charging Cradle

| Feature               | Description  |
|-----------------------|--|
| Dimensions            | Height: 8.6 cm (3.4 in.)<br>Width: 31.6 cm (12.4 in.)<br>Depth: 10.6 cm (4.2 in.)                    |
| Weight                | 426 g (15.0 oz)  |
| Input Voltage         | 5 VDC, 9 VDC, 12 VDC via PD adapter  |
| Power Consumption     | 36 watts   |
| Operating Temperature | 0°C (32°F) to +40°C (+104°F)   |
| Storage Temperature   | -40°C (-40°F) to +70°C (+158°F)  |
| Charging Temperature  | 0°C to 40°C (32°F to 104°F)  |
| Humidity              | 5% to 95% non-condensing   |
| Drop                  | 75 cm (30 in.) to concrete, 2 drops per side for a total 12 drops at room temperature 23°C (73.4°F). |

**Table 36** 1-Slot PD Charging Cradle (Continued)

| Feature                       | Description  |
|-------------------------------|--|
| Electrostatic Discharge (ESD) | +/- 15 kV air<br>+/- 8 kV contact<br>+/- 8 kV indirect |

## 4-Slot Charge Only Cradle Specifications

This section provides specification information on the 4-Slot Charge-Only Cradle with Battery Charger.

**Table 37** 4-Slot Charge-Only Cradle

| Feature                       | Description  |
|-------------------------------|--|
| Dimensions                    | Height: 15.6 cm (6.1 in.)<br>Width: 21.6 cm (8.5 in.)<br>Depth: 52.4 cm (20.6 in.)                   |
| Weight                        | 3133 g (110.5 oz)  |
| Input Voltage                 | 12 VDC   |
| Power Consumption             | 100 watts (including the 4-Slot PowerPack Charger)   |
| Operating Temperature         | 0°C (32°F) to +50°C (+122°F)   |
| Storage Temperature           | -40°C (-40°F) to +70°C (+158°F)  |
| Charging Temperature          | 0°C to 40°C (32°F to 104°F)  |
| Humidity                      | 5% to 95% non-condensing   |
| Drop                          | 75 cm (30 in.) to concrete, 2 drops per side for a total 12 drops at room temperature 23°C (73.4°F). |
| Electrostatic Discharge (ESD) | +/- 15 kV air<br>+/- 8 kV contact  |

## 4-Slot PowerPack Specifications

The following table provides technical specifications for the 4-Slot PowerPack Charger.

**Table 38** 4-Slot PowerPack Charger Technical Specifications

| Item       | Description  |
|------------|--|
| Dimensions | Height: 10.2 cm (4.0 in.)<br>Width: 9.7 cm (3.8 in.)<br>Depth: 13.2 cm (5.2 in.) |
| Weight     | 512 g (18.0 oz.)   |

**Table 38** 4-Slot PowerPack Charger Technical Specifications (Continued)

| Item                          | Description   |
|-------------------------------|---|
| Input Voltage                 | 12 VDC  |
| Power Consumption             | up to 50 watts  |
| Operating Temperature         | 5°C to 40°C (41°F to 104°F)   |
| Storage Temperature           | -40°C to 70°C (-40°F to 158°F)  |
| Charging Temperature          | 5°C to 40°C (41°F to 104°F)   |
| Humidity                      | 5% to 95% non-condensing  |
| Drop                          | 76.2 cm (30.0 in.) drops to vinyl tiled concrete at room temperature. |
| Electrostatic Discharge (ESD) | +/- 20 kV air<br>+/- 10 kV contact<br>+/- 10 kV indirect discharge    |

## 8 in. Expansion Back Specifications

This section provides specification information on the 8 in. Expansion Back.

**Table 39** 8 in. Expansion Back

| Feature                       | Description  |
|-------------------------------|--|
| Dimensions                    | Height: 104.6 mm (4 in.)<br>Width: 151.4 mm (6 in.)<br>Depth: 50.8 mm (2 in.)  |
| Weight                        | Without PowerPack: 167 g (5.9 oz)<br>With PowerPack: 334 g (11.8 oz)   |
| Operating Temperature         | -20°C to 50°C (-4°F to 122°F)  |
| Storage Temperature           | -40°C to 70°C (-40°F to 158°F)   |
| Humidity                      | 5% to 95% non-condensing   |
| Drop                          | 1.0 m (3.28 ft) drop to plywood over concrete per MIL-STD 810G across operating temperatures without rugged frame.<br>1.2 m (4 ft) drop to plywood over concrete per MIL-STD 810G across operating temperatures with rugged frame. |
| Electrostatic Discharge (ESD) | +/- 15 kV air<br>+/- 8 kV contact  |

## 10 in. Expansion Back Specifications

This section provides specification information on the 10 in. Expansion Back.

**Table 40** 10 in. Expansion Back

| Feature                       | Description  |
|-------------------------------|--|
| Dimensions                    | Height: 124.9 mm (4.9 in.)<br>Width: 168.2 mm (6.6 in.)<br>Depth: 52.3 mm (2.1 in.)  |
| Weight                        | Without PowerPack: 183 g (6.5 oz)<br>With PowerPack: 350 g (12.3 oz)   |
| Operating Temperature         | -20°C to 50°C (4°F to 122°F)   |
| Storage Temperature           | -40°C to 70°C (-40°F to 158°F)   |
| Humidity                      | 5% to 95% non-condensing   |
| Drop                          | 1.0 m (3.28 ft) drop to plywood over concrete per MIL-STD 810G across operating temperatures without rugged frame.<br>1.2 m (4 ft) drop to plywood over concrete per MIL-STD 810G across operating temperatures with rugged frame. |
| Electrostatic Discharge (ESD) | +/- 15 kV air<br>+/- 8 kV contact  |

